

Digital Multifunction Meter - RISH *Integra* 2000

Features

- >> Four line graphic LCD display
- >> 100+ parameters
- >> Fast communications
- >> Customer configurable
- >> Easy to use
- >> Output options:
 - 4 x 0-1mA
 - 4 x 4-20mA
 - 1 or 2 energy pulses
- >> Panel mounted
- >> Neutral current measurement
- >> L-L values on a 4 wire system
- >> Maximum demand reset via RS485
- >> Variable screen update time
- >> Average or sum of currents

Typical Applications

- Import & export power monitoring
- Medium to high voltage distribution
- Low voltage switchgear
- Generator sets
- Secondary metering
- Process measurement and communications
- S.C.A.D.A./T elemetry systems
- Building management systems

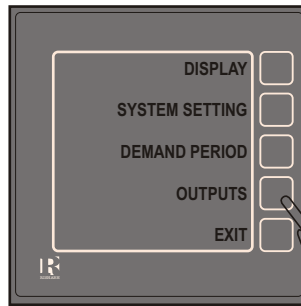

The *RISH Integra* 2000 is a panel mounted power measuring instrument for the display and communication of electrical parameters.

It integrates high accuracy measurement technology with the simplicity and distinctiveness of a high resolution graphic display.

Operation

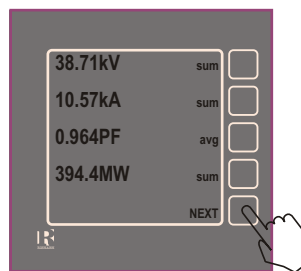

Active readings

- Character sizes to distinguish between active reading, parameter, relationship & key function
- Most common parameters available in two keystrokes
- By pressing "Next" the active screen reduces by 25% to reveal user "SOFT PROMPTS"
- Soft prompts are assigned to the adjacent key to guide the user simply and efficiently to the required reading

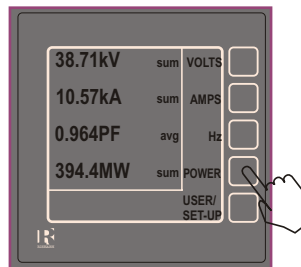

Simple to Use

- By pressing "POWER", for example, the active screen changes to display power related parameters

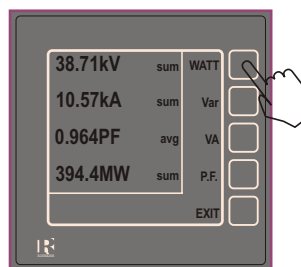

Easy Access to Data

- By pressing "W ATT" the active screen would display Watts by phase and sum, the soft prompts would offer "Min", "Max", "Hold" & "Exit"

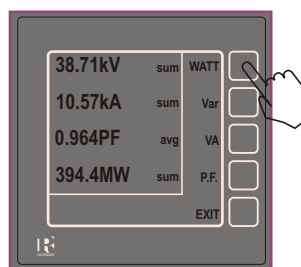

User Programmable

- "SET -UP" - check, accesses the user defined screens and the configuration screens
- Set-up screens are passcode protected
- CONFIGURE, accesses features such as C.T .&P.T. ratios, output configuration, reset etc.

Digital Multifunction Meter - RISH *Integra* 2000

Benefits

- >> Large characters for easy viewing
- >> LCD back lighting for viewing in low ambient light
- >> High screen resolution allows use of text and graphics
- >> User friendly interface via on screen prompts
- >> Tactile keypad for positive key presses
- >> User programmable screens
- >> Excellent harmonic handling for true power measurements
- >> R.M.S. measurement for accurate readings of distorted waveforms
- >> High accuracy maintained over a wide measuring range
- >> Meets world-wide industry standards (Safety, Performance, EMC etc)
- >> Measures importing & exporting systems

Communications Interface for:

- Modbus RTU
- Profibus
- LonWorks
- Device Net
- Johnson Controls
- Satchwell
- Honeywell
- Siemens
- RS232

User Programmable Features

- C.T. Ratio
- P.T. Ratio
- User screen-any four of up to 42
- Average or sum of current on default screen
- Analog outputs-any four of up to 36
- Demand period and sub interval
- Resetting of counters
- Pulsed Output - any 1 or 2 of 6 energy values duration 20-200mS
Power divisions 1, 10, 100 or 1000
1 pulse = 1kW.h or 1MW.h
- RS485
Node Address
Parity / stop bits
Speed 2.4 - 19.6 Kbps

System Input

The RISH *Integra* 2000 is designed to provide continuous monitoring of industry standard High, Medium and Low voltage three phase systems (voltage & current transformers required). The Current and Voltage are sampled using sophisticated mathematical routines which ensure *Integra* 2000 provides accurate measurement over a large range of inputs, even under adverse waveform conditions.

Digital Outputs

By means of an internal communication Module RISH *Integra* 2000 can transmit digital information via RS232 and RS485.

Process instrumentation and plant automation equipment can be connected with RISH *Integra* 2000 into your S.C.A.D.A. or PLC system.

The RS485 network is electrically connected To RISH *Integra* 2000 via two wire twisted pair leads. Many units can be connected together using either line or loop topology.

Pulsed Outputs

The pulsed output module supplies pulses proportional to the measured energy.

Both relays are user definable to any two of the hours related energy parameters. e.g. Import or Export, Wh, VARh, VAh and Ah.

The measured range covers the full four quadrants, hence the output can represent

Analogue Outputs

The analogue module provides four 0-1mA isolated outputs, self powered or 4 x 4-20mA D.C. outputs (additional 24V D.C. power supply required).

These outputs are individually programmable to represent any one of the measured parameters, A, V, Hz, W, VAR, PF, VA.

The output signal is proportional to the measured parameter and is therefore ideal for transmission to devices which can record trend over time, such as a chart recorder or

From the 32 samples of each waveform taken, the RMS value of every current and voltage input is determined, as is the power and quadrant information. This measuring input technique is essential in providing precise and consistent measurement in today's environment of non-linear loads.

Communication is achieved using industry standard protocols and the latest technology available

The RS232 uni-directional serial port outputs all base (A, V, Hz, W, PF) parameters via a high efficiency, low cost fiber optic link. Conversion of the optical data back to RS232 is achieved by using a simple interface convertor connected to the serial port of the remote unit using an ASCII character data string at 9600 baud.

Inductive or Capacitive and Import or Export.

Relay contacts are volt free and fully isolated.

The pulse width and rate are user definable:-

Standard = One kWh or MWh per pulse
Maximum pulse rate 3600/h
Standard pulse width 50msec

simply displaying trend on a standard analogue instrumentation.

By the use of an external shunt resistor the mA output signal can easily be converted to a D.C. voltage.

The full scale output or nominal input are represented as a percentage of the selected parameter.

Connection is made via a five way, two part, clamp connector capable of accepting 12AWG cable.

Digital Multifunction Meter - RISH *Integra* 2000

Features as Standard

- >> Analogue outputs:
4 x 0-1mA D.C. self powered or 4 x 4-20mA D.C. External 24V D.C. Auxiliary required
- >> RS485. Modbus® RTU or Johnson Controls METASYS
- >> RS232 Fiber Optic repeater output
- >> Pulsed outputs, one or two
- >> OEM version, customer logo on the keypad
- >> D.C. Auxiliary power supply
- >> IP65 front panel sealing
- >> Transparent hinged cover
- >> 1 Amp input

Specification

Voltage:	600V Maximum (120%) Accuracy Range 10 - 100% Range of use 5 - 120%
Current:	5 amps. Accuracy Range 10 - 100% Range of use 5 - 120%
Frequency:	45 to 66Hz
Power Factor:	Range of use -1/ 0/1/0/-1 Import/Export, Lag/Lead
Overloads	
Voltage:	2x applied 10 times for 1second at 10 second intervals
Current:	20x overload applied 5times for 1 second at 5minute intervals Maximum continuous terminal current 6A

Burden

Voltage:	Each phase 0.2VA
Current:	Each phase 0.6VA

Outputs (optional)

Digital	Ports:	
	1 off - RS485 Protocol	Modbus® RTU Style 2 way 2 part screw clamp
	1 off - RS232 Communications	ASCII data string Fiber Optic
Analogue	Type:	
	4 off - Linear	0-1mA D.C. into 2k Uni-directional or
	4 off - Linear	4-20mA D.C. into 500Ω Uni-directional externally powered 5 way 2 part screw
	Style clamp	
Pulsed	Type:	
	Relay Switching Style	SPNO 100V D.C. 0.5A 2 part screw clamp

Isolation

Input to Digital O/P	Fiber = Infinite RS485 = 3kV
Input to Analog O/P	= 3kV
Input to Pulsed O/P	= 3kV

Accuracy Class

Voltage:	0.5% of reading ±4 Digits
Current:	0.5% of reading ±4 Digits
Power:	1.0% of reading ±4 Digits
Frequency:	0.1% of mid freq. ±2 Digits
Phase Angle/ Power Factor:	1.0% of reading ±4 Digits
Display update:	1 per second
Analogue O/P:	1.5% of ES
Analogue Update:	1 per second
Digital O/P:	As accuracies above
Repeater:	As accuracies above, update every second
Climatic Temperature:	Operating 0-50°C Storage -20-65°C Calibration 23°C
Temp Coeff:	±0.013%/°C
Humidity:	95% RH non condensing
Enclosure Code:	IP54 IP65 Optional

Auxiliary Supply

Standard	100 - 250V A.C./D.C.
Optional	12 - 48V D.C.
Burden:	3VA

Standards and Approvals

	UL recognized (File No. E140758) UL Listing for USA & Canada CE marked Consult factory for other approvals
Safety:	IEC 1010/BSEN 61010-1, UL1244 & CSA 22-2 (General electrical and mechanical safety requirement) IEC 664, VDE 0110, PD 6499 (insulation on low voltage systems)
Enclosure:	EN60529, IEC 529, BS5490, (IP ratings & Fixings) DIN 43700 (Housing)
EMC:	Emissions BSEN50081/1 Immunity BSEN50082/2
Test Method:	Performance BS4889, IEC 359, BSEN 61036, IEC 1036 (kWh functionality)

Digital Multifunction Meter - RISH *Integra* 2000

Parameter	Description	User Screen Output			Analog				RS232 % of nominal		Pulsed Output
		4W	3W	1Ø	4W	3W	1Ø	Scaling			
None	No assigned value	✓	✓	✓	✓	✓	✓	zero			✓
V1	Volts 1	✓		✓	✓		✓	0-100%	✓	✓	
V2	Volts 2	✓			✓			0-100%	✓		
V3	Volts 3	✓			✓			0-100%	✓		
VAVG	Volts Average	✓			✓		✓	0-100%			
V L1/L2	Volts L1-L2	✓	✓		✓	✓		0-100%	✓	✓	
V L2/L3	Volts L2-L3	✓	✓		✓	✓		0-100%	✓		
V L3/L1	Volts L3-L1	✓	✓		✓	✓		0-100%	✓		
V L/L AVG	Volts L-L Average	✓	✓		✓	✓		0-100%			
I1	Current 1	✓	✓	✓	✓	✓	✓	0-100%	✓	✓	✓
I2	Current 2	✓	✓		✓	✓		0-100%	✓	✓	✓
I3	Current 3	✓	✓		✓	✓		0-100%	✓	✓	
I SUM	Current Sum	✓	✓	✓	✓	✓	✓	0-100%			
IAVG	Current Average	✓	✓	✓	✓	✓	✓	0-100%			
INeutral	Neutral Current	✓			✓			0-100%			
W 1	Watts 1	✓		✓	✓		✓	0-100%	✓	✓	
W 2	Watts 2	✓			✓			0-100%	✓		
W 3	Watts 3	✓			✓			0-100%	✓		
W SUM	Watts Sum	✓	✓	✓	✓	✓	✓	0-100%			
VAr 1	VAr 1	✓		✓	✓		✓	0-100%	✓	✓	
VAr 2	VAr 2	✓			✓			0-100%	✓		
VAr 3	VAr 3	✓			✓			0-100%	✓		
VAr SUM	VAr Sum	✓	✓	✓	✓	✓	✓	0-100%			
VA 1	VA 1	✓		✓	✓		✓	0-100%	✓	✓	
VA 2	VA 2	✓			✓			0-100%	✓		
VA 3	VA 3	✓			✓			0-100%	✓		
VA SUM	VA Sum	✓	✓	✓	✓	✓	✓	0-100%			
Frequency	Hz	✓	✓	✓	✓	✓	✓	45 - 65Hz	✓	✓	✓
Phase Angle 1	Phase Angle 1	✓		✓	✓		✓	+180-0- -180°			
Phase Angle 2	Phase Angle 2	✓			✓			+180-0- -180°			
Phase Angle 3	Phase Angle 3	✓			✓			+180-0- -180°			
Phase Angle Average	Phase Angle Average	✓	✓	✓	✓	✓	✓	+180-0- -180°			
PF 1	Power Factor 1	✓		✓	✓		✓	+180-0- -180°			
PF 2	Power Factor 2	✓			✓			+180-0- -180°			
PF 3	Power Factor 3	✓			✓			+180-0- -180°			
PF AVG	Power Factor Average	✓	✓	✓	✓	✓	✓	+180-0- -180°			
IMP WATT Hr	Import Watt Hours	✓	✓	✓							✓
EXP WATT Hr	Export Watt Hours	✓	✓	✓							✓
IMP VAR Hr	Import Var Hours	✓	✓	✓							✓
EXP VAR Hr	Export Var Hours	✓	✓	✓							✓
VA HOUR	VA Hours	✓	✓	✓							✓
A HOUR	Amp Hours	✓	✓	✓							✓

Digital Multifunction Meter - RISH *Integra* 2000

Parameters available via display and RS485 Modbus

Address	Parameter	Wire			Address	Parameter	Wire		
		4	3	2			4	3	2
1	Volts 1	✓	✓	✓	57	Volts 2 Max.	✓	✓	X
2	Volts 2	✓	✓	X	58	Volts 2 Min.	✓	✓	X
3	Volts 3	✓	✓	X	59	Volts 3 Max.	✓	✓	X
4	Current 1	✓	✓	✓	60	Volts 3 Min.	✓	✓	X
5	Current 2	✓	✓	X	61	Current 1 Max.	✓	✓	✓
6	Current 3	✓	✓	X	62	Current 1 Min.	✓	✓	✓
7	Watts 1	✓	X	✓	63	Current 2 Max.	✓	✓	X
8	Watts 2	✓	X	X	64	Current 2 Min.	✓	✓	X
9	Watts 3	✓	X	X	65	Current 3 Max.	✓	✓	X
10	VA 1	✓	X	✓	66	Current 3 Min.	✓	✓	X
11	VA 2	✓	X	X	67	Volts Ave Max.	✓	✓	✓
12	VA 3	✓	X	X	68	Volts Ave Min.	✓	✓	✓
13	VAr 1	✓	X	✓	69	Volts Sum Max.	X	X	X
14	VAr 2	✓	X	X	70	Volts Sum Min.	X	X	X
15	VAr 3	✓	X	X	71	Current Ave Max.	X	X	X
16	Power Factor 1	✓	X	✓	72	Current Ave Min.	X	X	X
17	Power Factor 2	✓	X	X	73	Current Sum Max.	✓	✓	✓
18	Power Factor 3	✓	X	X	74	Current Sum Min.	✓	✓	✓
19	Phase Angle 1	✓	X	✓	75	Watt 1 Max.	✓	X	✓
20	Phase Angle 2	✓	X	X	76	Watt 1 Min.	✓	X	✓
21	Phase Angle 3	✓	X	X	77	Watt 2 Max.	✓	X	X
22	Volts Ave	✓	✓	✓	78	Watt 2 Min.	✓	X	X
23	Voltage Sum	X	X	X	79	Watt 3 Max.	✓	X	X
24	Current Ave	✓	✓	✓	80	Watt 3 Min.	✓	X	X
25	Current Sum	✓	✓	✓	81	Watt Sum Max.	✓	✓	✓
26	Watts Ave	X	X	X	82	Watt Sum Min.	✓	✓	✓
27	Watts Sum	✓	✓	✓	83	VAr 1 Max.	✓	X	✓
28	VA Ave	X	X	X	84	VAr 1 Min.	✓	X	✓
29	VA Sum	✓	✓	✓	85	VAr 2 Max.	✓	X	X
30	VAr Ave	X	X	X	86	VAr 2 Min.	✓	X	X
31	VAr Sum	✓	✓	✓	87	VAr 3 Max.	✓	X	X
32	Power Factor Ave	✓	✓	✓	88	VAr 3 Min.	✓	X	X
33	Power Factor Sum	X	X	X	89	VAr Sum Max.	✓	✓	✓
34	Phase Angle Ave	✓	✓	✓	90	VAr Sum Min.	✓	✓	✓
35	Phase Angle Sum	X	X	X	91	VA 1 Max.	✓	X	✓
36	Frequency	✓	✓	✓	92	VA 1 Min.	✓	X	✓
37	W.H Import	✓	✓	✓	93	VA 2 Max.	✓	X	X
38	W.H Export	✓	✓	✓	94	VA 2 Min.	✓	X	X
39	VAr.H Import	✓	✓	✓	95	VA 3 Max.	✓	X	X
40	VAr.H Export	✓	✓	✓	96	VA 3 Min.	✓	X	X
41	VA.H	✓	✓	✓	97	VA Sum Max.	✓	✓	✓
42	A.H	✓	✓	✓	98	VA Sum Min.	✓	✓	✓
43	W Demand Import	✓	✓	✓	99	Frequency Max.	✓	✓	✓
44	W Max. Demand Import	✓	✓	✓	100	Frequency Min.	✓	✓	✓
45	W Demand Export	✓	✓	✓	101	V L1-L2	✓	X	X
46	W Max. Demand Export	✓	✓	✓	102	V L2-L3	✓	X	X
47	VAr Demand Import	✓	✓	✓	103	V L3-L1	✓	X	X
48	VAr Max. Demand Import	✓	✓	✓	104	V L-L Ave	✓	X	X
49	VAr Demand Export	✓	✓	✓	105	V L1-L2 Max	✓	X	X
50	VAr Max. Demand Export	✓	✓	✓	106	V L1-L2 Min	✓	X	X
51	VA Demand	✓	✓	✓	107	V L2-L3 Max	✓	X	X
52	VA Max. Demand	✓	✓	✓	108	V L2-L3 Min	✓	X	X
53	A Demand	✓	✓	✓	109	V L3-L1 Max	✓	X	X
54	A Max. Demand	✓	✓	✓	110	V L3-L1Min	✓	X	X
55	Volts 1 Max.	✓	✓	✓	111	V L-L Ave Max	✓	X	X
56	Volts 1 Min.	✓	✓	✓	112	V L-L Ave Min	✓	X	X
					113	I Neutral	✓	X	X

Digital Multifunction Meter - RISH *Integra* 2000

Connections

Wiring

Input connections are made directly to shrouded screw clamp terminals. Numbering is clearly marked on the plastic moulding. Choice of cable should meet local regulations. Terminals for both current and voltage inputs will accept up to two 12 AWG diameter cables.

Auxiliary Supply

RISH Integra 2000 ideally should be powered by a dedicated supply, however it may be powered by the signal source, providing the source remains within $\pm 10\%$ of the chosen auxiliary voltage.

Fusing

It is recommended that all voltage lines are fitted with 1 amp HRC fuses.

Earth/Ground Connections

For safety reasons, C.T. secondary connections should be grounded according to local codes of practice.

Import/Export Connections

The connections shown assume an import power configuration and therefore power factor is shown as import (IMP). Current will flow towards the load, if current flows away from the load, in an export power situation, then the power factor indication will change to export (EXP). This negates the need for separate export connections, because **RISH Integra** 2000 serves the full four conditions of power factor.

Connection Diagrams

3-Phase 4-Wire Unbalanced Load

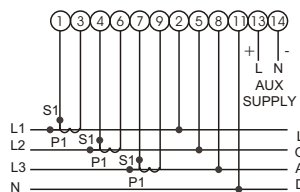

3-Phase 3-Wire Unbalanced Load

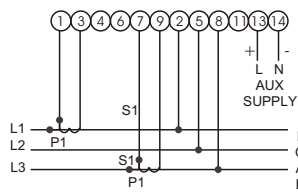

Single Phase

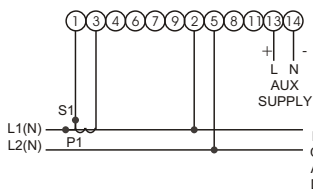

Dimensions

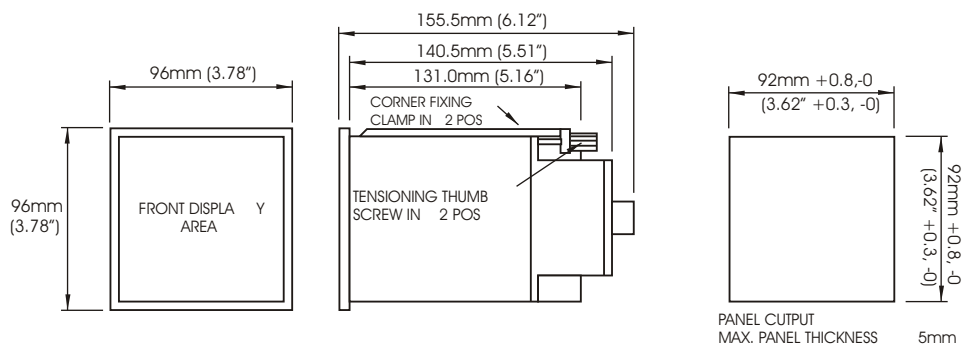

* Parameters available vary depending upon protocol/interface style



RISHABH
INSTRUMENTS
Measure, Control & Record with a Difference

RISHABH INSTRUMENTS PVT.LTD.
F-31, MIDC, Satpur, Nashik-422 007, India.
Tel.: +91 253 2202160, 2202202 Fax : +91 253 2351064
E-mail : marketing@rishabh.co.in
www.rishabh.co.in

Digital Multifunction Meter - RISH *Integra* 2000

Selector Guide

CATALOG#		244-IN		W											
CONFIGURATION															
CODE	DESCRIPTION														
K	Single phase														
M	3 Phase 3 Wire, Unbalanced, 2 Elements														
W	3 Phase 4 Wire, Unbalanced, 3 Elements														
MEASURED INPUT															
CODE	DESCRIPTION	UL													
QL	69V L-N, 5A	*													
PN	110V L-N, 5A	*													
QP	115V L-N, 5A	*													
QQ	120V L-N, 5A	*													
VQ	220V L-N, 5A	*													
VR	230V L-N, 5A	*													
QS	240V L-N, 5A	*													
QY	277V L-N, 5A	*													
QP	110V L-L, 5A	*													
PQ	120V L-L, 5A	*													
QR	208V L-L, 5A	*													
QX	380V L-L, 5A	*													
QT	480V L-L, 5A	*													
AUXILIARY															
CODE	DESCRIPTION	UL													
A5	12 - 48V D.C.	*													
A2	100 - 250V A.C./D.C.	*													
COMMUNICATIONS (optional-select one)															
CODE	DESCRIPTION	UL													
32	RS232 FIBER OPTIC O/P	*													
48	RS485 MODBUS @ O/P	*													
JC	MODBUS @ RTU PROTOCOL														
	JOHNSON CONTROLS NII														
	OPEN PROTOCOL														
PB	PROFIBUS-DP														
LW	LONWORK														
DN	DEVICE NET														
ANALOG OUTPUTS (optional-select one)															
CODE	DESCRIPTION	UL													
A2	4 x 4-20mA O/P, Max load 500 ohms	*													
A4	4 x 1mA O/P, Max load 2000 ohms	*													
PULSED OUTPUTS (optional-select one)															
CODE	DESCRIPTION	UL													
P1	ONE PULSED OUTPUT (kW.h)	*													
P2	TWO PULSED OUTPUTS	*													
OPTIONS															
CODE	DESCRIPTION														
TC	HINGED COVER														
65	IP 65 (FRONT OF PANEL)														
MG	PANEL GASKET														

* = UL RECOGNIZED

ORDERING INFORMATION:

SUBSTITUTE BOX WITH LETTER CODE - EXAMPLE: 244-INMW-PQ HG-48-P1
 = 3 PHASE 3 WIRE, 120V-L 5A, AUX 120V 50/60HZ, RS485 COMMS AND ONE PULSED O/P
 CONTACT FACTOR Y FOR NON-LISTED INPUTS OR OTHER REQUIREMENTS



RISHABH
INSTRUMENTS
 Measure, Control & Record with a Difference

RISHABH INSTRUMENTS PVT.LTD.
 F-31, MIDC, Satpur, Nashik-422 007, India.
 Tel.: +91 253 2202160, 2202202 Fax : +91 253 2351064
 E-mail : marketing@rishabh.co.in
 www.rishabh.co.in