



# HIOKI

## CLAMP ON POWER LOGGER PW3365-20

Power Meter



### Eliminate the risk of short-circuits and electrical accidents

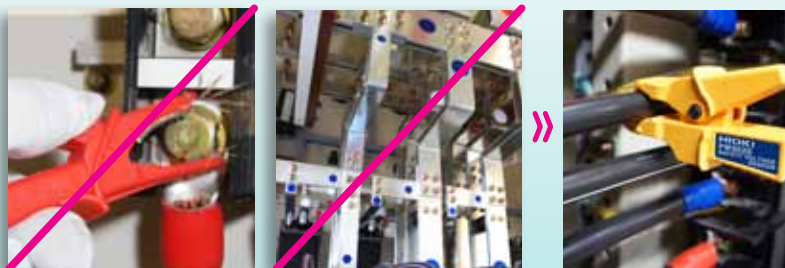

The world's first instrument to offer no-metal-contact power measurement

Free from the risk of short-circuit accidents since no metal comes into contact with energized parts, the Clamp On Power Logger PW3365-20 can measure voltage, current, and power right on the cable, letting you safely test in locations that were dangerous or even impossible in the past.



ISO 9001  
JMI-0216



ISO 14001  
JQA-E-90091



[www.hioki.com](http://www.hioki.com)

HIOKI company overview, new products, environmental considerations and other information are available on our website.



# Safe, Easy, Voltage Measurement

The PW3365-20's dedicated voltage sensor delivers the world's first no-metal-contact measurement.

Free yourself from the risk of short-circuits by measuring right on the cable sheath without ever needing to touch metal to energized parts



Freely clip either horizontally or vertically



Measure both thick and thin cables

Measure in potentially hazardous locations



Locations without energized parts

Measure on the outside of cables



Locations with covered terminals

Measure without removing the covers

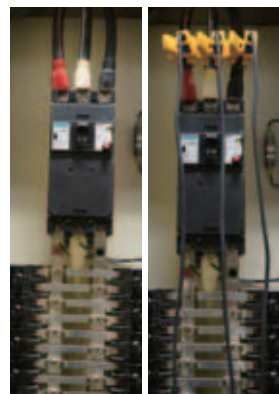

Locations with a risk of electric shock

Measure at safer points



How is voltage measured without any metallic contact?

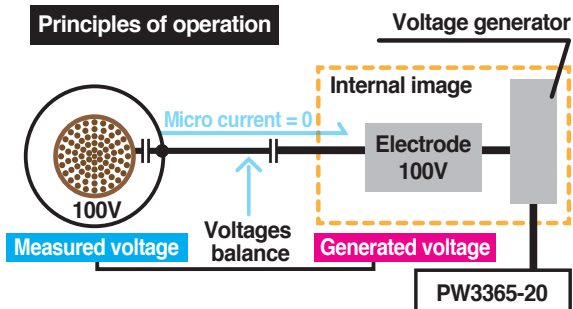
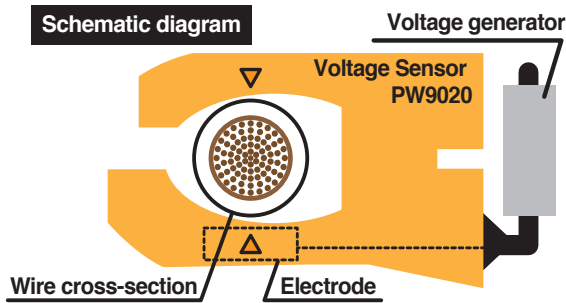

Inside the PW9020 is an electrode (a metal plate). When there is a potential difference between this electrode and the measured line, a minute current flows as a result. By detecting this minute current and generating a voltage such that the current declines to zero, it is possible to accurately measure the voltage without being affected by the outer diameter of the measured cable or its insulation.





Enlarged view of clamp

Actual maximum size :  $\phi 30\text{mm}$   
Actual minimum size :  $\phi 6\text{mm}$

Compatible conductor diameters

### SAFETY VOLTAGE SENSOR PW9020 Specifications

Compatible conductor types	Insulated wires* <sup>1</sup> In door PVC or metal parts
Compatible conductor diameters	Finished outer diameter $\phi 6\text{mm}$ to $\phi 30\text{mm}$
Effective measurement range	90 V to 520 V
Accuracy	$\pm 1.5\%$ rdg. $\pm 0.2\%$ f.s. (combined accuracy with PW3365-20)* <sup>2</sup>
Effect of phase	Accuracy combined with the PW3365-20 is within $\pm 1.3\%$ (at 50/60Hz, f.s. input)
Maximum rated voltage to earth	CATIV 300V / CATIII 600V
Cord length	3m (9.84 ft)
Mass	Approx. 220g (7.8 oz)
Operating temperature and humidity	0°C to 50°C (32°F to 122°F), 80% RH or less (no condensation)
Storage temperature and humidity	-10°C to 60°C (14°F to 122°F), 80% RH or less (no condensation)
Dielectric strength	7.06k Vrms AC
Applicable standards	Safety: EN61010, EMC: EN61326



\* includes relay box on cord



Soil, residue, or moisture on the insulated wires may result in lower voltage and power values than their true values. Use a dry cloth to remove before measuring.

\*<sup>1</sup>: Shielded wires cannot be measured.\*<sup>2</sup>: For frequencies of 45 Hz to 66 Hz.

Effects of humidity: Add the following to the combined accuracy (for voltage, power, and phase) with the PW3365-20  
Accuracy within  $\pm 1\%$  f.s., phase within  $\pm 1^\circ$ ,  
measuring an insulated wire at a humidity of 70% to 80% RH  
Effects of adjacent wires: Add the following to the combined accuracy (for voltage and power) with the PW3365-20  
Within  $\pm 1\%$  f.s. while a wire with a phase difference of 400 V is in contact with the grip

# Configure Settings with Quick Set

## Graphical, easy-to-understand guidance for connection procedures

Quick Setup guides you through the process of setting up the instrument for measurement, right up to starting measurement, on the screen to simplify set work. Since any mistaken connections will trigger a FAIL message, the feature also helps prevent measurement mistakes. If you receive a FAIL result, the instrument will also indicate the location of the problem.



### Setup Flow (example: 3P4W)

STEP1 Quick Set START / Choose the wire type

STEP2 Connect the leads to the PW3365-20



STEP3 Connect the voltage sensor



STEP4 Connect the clamp sensors



STEP5 Select the current range

STEP6 Check wire connection status

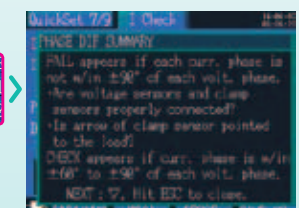
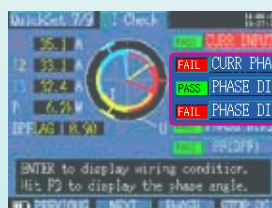

### If you receive a FAIL result

Highlight the FAIL message with the cursor and press ENTER to view information about where the connection needs to be corrected.

Measurement

### Miswiring Example (Clamp Orientation)

Neither power nor power factor can be measured accurately with the clamp in the wrong orientation.

Correct Orientation

Point the arrow toward the load side

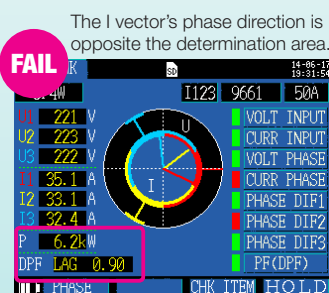
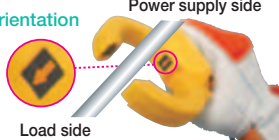

P: 6.2kW  
Power displayed value is too low

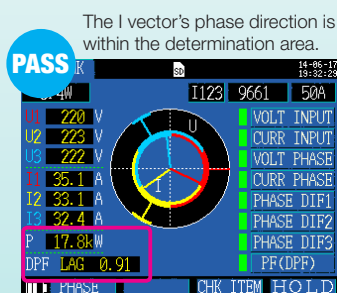

P: 17.8kW

■ CURR PHASE Red means : FAIL ■ VOLT PHASE Green means : PASS



# Review Results At the Worksite

## Display measured values as a graph and evaluate results at a glance

Measured values can be displayed as a graph, which is convenient when using the instrument in power management applications. Since you can statistically review not only the measured value at that moment, but also measured values that have been recorded, it's easy to check values on the spot.

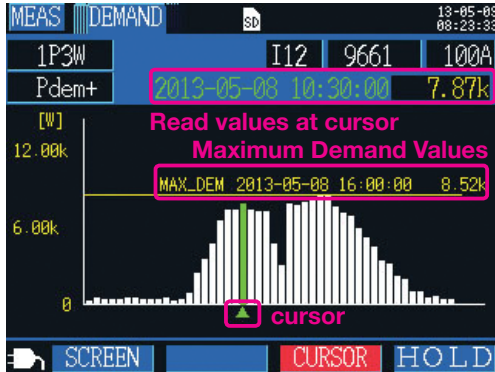

Bar graph of values measured over a period of 24 hours at a 30-minute interval

### Demand Graph Display

#### Display demand value trends

It's easy to check the maximum demand value and the time at which it occurred.

Particularly useful in power management applications

#### Evaluate Photovoltaic Generation Capabilities

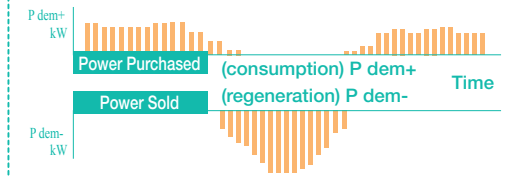

You can create a bar graph that makes it obvious whether power is being bought or sold by switching the active power demand value display from consumption to regeneration

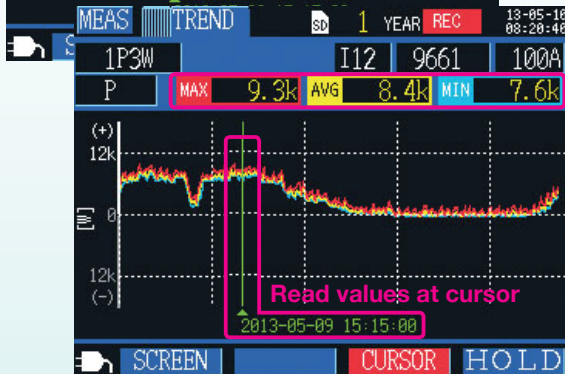
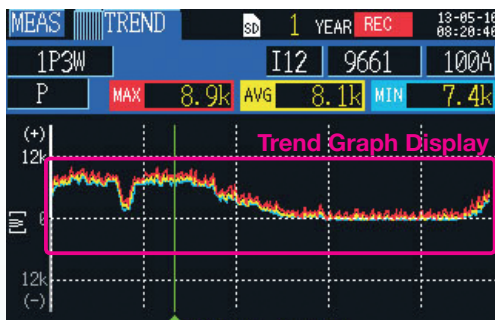

Graph of values measured over a period 24 hours at 5-minute intervals

### Trend Graph Display

\* Except for demand

#### Choose one measured parameter to create a time-series display as a graph

Monitor power variations to check for connections between equipment operating status and power consumption.

#### Display the maximum, minimum, and average values at the cursor position

Identify these parameters right on the time-axis graph display

Example  
Power trend graph display

- MAX 9.3k** Maximum Value
- MIN 7.6k** Minimum Value
- AVG 8.4k** Average Value

#### Capture and record all fluctuations

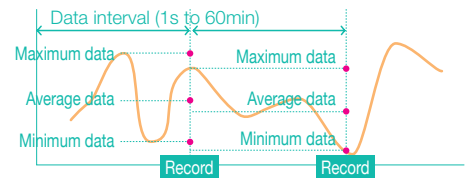

Set the power logger to save all parameters to record the maximum, minimum, and average values during the set recording interval.



### Display electricity charges

#### Convert integrated power use to electricity charges

Know how much you are spending on electricity in real-time

#### Displaying electricity charges

Active power use 1 kWh × set rate



Calculate electricity charges

[ Example screenshot to left ]

The electricity charge per 1kWh has been set to \$20  
Active power use 53.7306kWh × set rate 20 USD

**electricity charges 1074.61 USD**

Save &amp; Analyze

# Results on a PC

## Easily download and interpret data on a PC

Download the measurement results to a computer via the power logger's LAN or USB interface or its SD card. Once data has been downloaded, it can be graphed easily with free software. For more detailed analysis, Hioki's optional SF1001 application software is recommended.

### Storage media for data

#### SD card 2GB

Stores up to one year's data that is acquired at one minute intervals. Performance cannot be guaranteed on storage media other than SD cards sold by Hioki.



### Loading data

#### SD card 2GB

#### LAN interface

#### USB interface

Use the free software from the Hioki website in order to download data to a computer using the instrument's LAN or USB interface



### Available Recording Time

Measurement Interval	Save Time	Measurement Interval	Save Time
1 seconds	15.6 days	30 seconds	1 year
2 seconds	31.2 days	1 minutes	1 year
5 seconds	77.9 days	2 minutes	1 year
10 seconds	155 days	5 minutes	1 year
15 seconds	233 days	More than 10 minutes	1 year

[ Save conditions for above figures ]

Measurement target : 3P4W

Storage media : Z4001 2-GB SD card

Saved parameters : All data: average, maximum, and minimum values

Screen copy saving : OFF Waveform save : OFF

In all cases, the maximum single file size for measurement data is about 200 MB. When this is exceeded, a new file is created and saving continues.

### Freeware (free download from the Hioki website)

#### Convenient Functions

- Load saved data directly from the instrument (via a USB/LAN connection)
- Graph saved data in Excel
- Transfer settings from a computer to the PW3365-20
- Print data

#### Automatically Create Excel Graphs

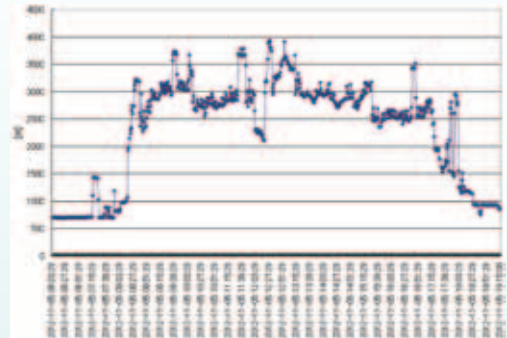
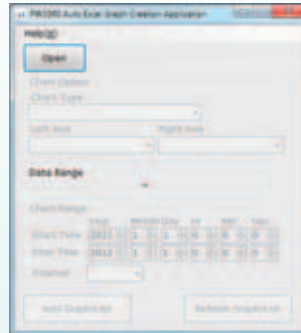

### Power Logger Viewer SF1001 (option, sold separately/for PW3365,PW3360,PW3198)

#### Display, tabulate, analyze, and print saved data

- Trend graph display
- Summary display
- Waveform display
- Copy
- Print
- Report printing

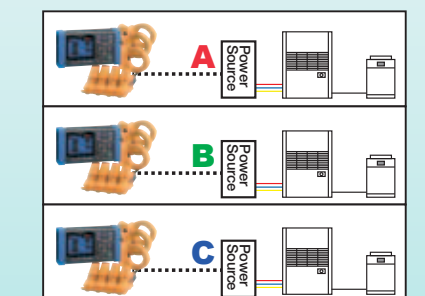

#### Example of a Stacked Graph Display

You can combine power consumption data measured at multiple locations into a single graph to capture the total power demand across a facility, allowing you to identify time periods and locations characterized by high power consumption at a glance.



# Convenient Functions For the Worksite

## More Uses for the PW3365-20

The Hioki PW3365-20 is not just a power logger. Added-value features and functions let you meet many other electrical testing applications.

### Leakage Current Measurement

Requires optional clamp-on leak sensor

#### Measure power + 1-channel of leakage current

Example : 3P3W2M+1-channel leakage current

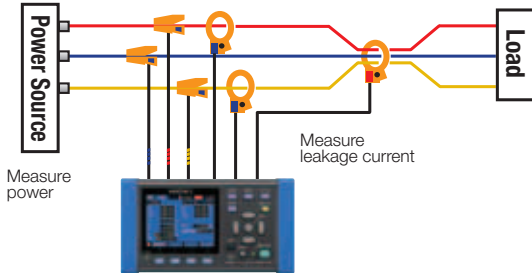

With the ability to calculate and process data every 200ms, you can do simple checks of intermittent leakage current. Choose from average, maximum and/or minimum value of the measured interval.

Leakage current results

MEAS	U/1	I3	9675	50mA
3P3W2M+1				
U1	RMS (V)	FND (V)	PEAK (V)	PHASE (deg)
U2	224.4	224.4	321.1	0.0
U12	223.3	223.3	326.0	59.9
U12	223.5	223.5	322.5	-59.9
I1	RMS (A)	FND (A)	PEAK (A)	PHASE (deg)
I2	23.420	19.984	33.475	-29.9
I12	22.079	18.952	44.459	90.3
I12	25.604	19.445	62.660	-152.5
I3	27.004m	24.924m	50.069m	59.5

By capturing the RMS of the fundamental wave, you can also identify the leakage current of the 50/60Hz component.

- RMS (A) RMS that includes harmonic components
- FND (A) RMS of fundamental wave
- PEAK (A) Peak value (waveform peak)

#### Measure 3 channels of leakage current

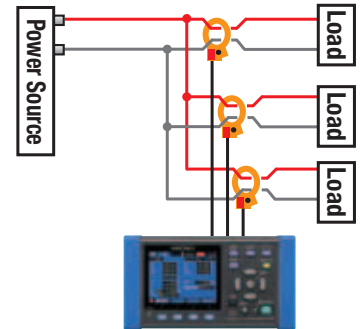

### Control and monitor from a remote location

#### Use a LAN cable to connect the PW3365-20 to a personal computer for real-time remote monitoring and measurement display on a web browser.

Files recorded in the Clamp On Power Logger's internal memory or SD card are accessible via a LAN or USB connection, and are downloadable using the free PW3365-20 Setup and Download Software

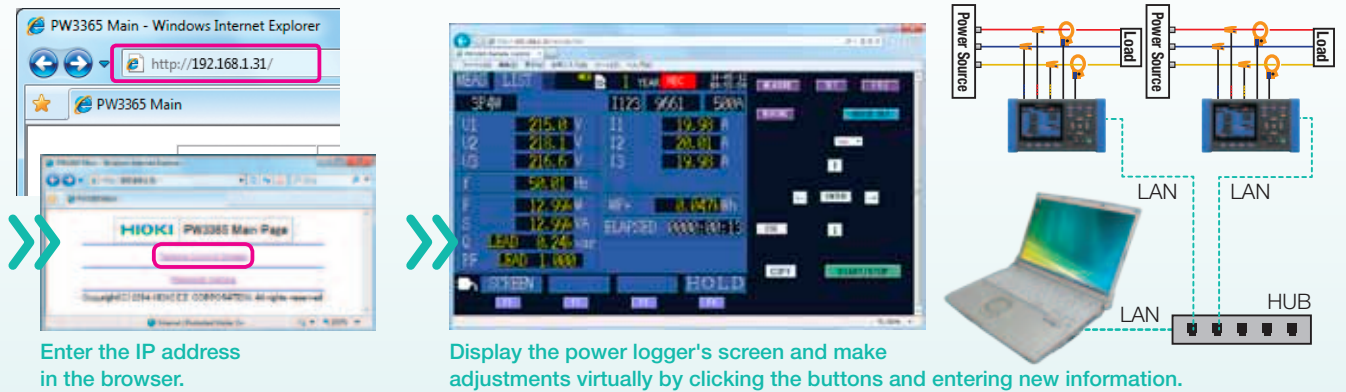

Enter the IP address in the browser.

Display the power logger's screen and make adjustments virtually by clicking the buttons and entering new information.

### Simultaneous Measurements

Measure three single-phase, 2-wire circuits in the same system at the same time.

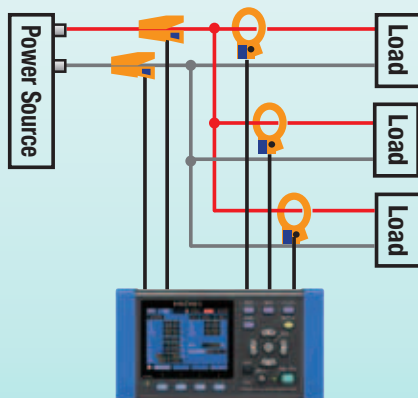

### Other convenient features



#### Compact, lightweight

Small form factor lets you set the power logger even inside cramped cubicles



#### Battery power

Power the instrument for about five hours with batteries if the power goes out



#### Outage recovery

Resume recording automatically following recovery from a power outage

#### Key lock function

Lock the buttons to prevent erroneous operation

#### Display hold

Freeze the displayed value for easier reading

# PW3365-20 Specifications

No dirt or moisture on insulated wire or voltage sensor  
Product guaranteed for one year

Measurement				
Number of input channels	Voltage: 3 channels / Current: 3 channels			
Measurement targets (50/60Hz)	Single-phase 2-wire (1P2W, 1P2W × 2 circuits, 1P2W × 3 circuits) Single-phase 3-wire (1P3W, 1P3W+I, 1P3W1U, 1P3W1U+I) Three-phase 3-wire (3P3W2M, 3P3W2M+I, 3P3W3M/Y-wiring only) Three-phase 4-wire (3P4W), Current only: 1 to 3 channels			
Simultaneous power/current measurement modes	1P3W+I : 1 power circuit and 1 current channel 3P3W2M+I : 1 power circuit and 1 current channel			
Measurement items	Voltage	RMS value, fundamental wave value, waveform peak (absolute value), fundamental wave phase angle, frequency (U1)		
	Current	RMS value, fundamental wave value, waveform peak (absolute value), fundamental wave phase angle		
	Power	Active power, reactive power, apparent power, power factor, (with lag/lead display) or displacement power factor (with lag/lead display), active energy (consumption, regeneration, regeneration), reactive energy(lag, lead) Energy cost display (per-kWh price × power consumption)		
	Demand	Active power demand value (consumption, regeneration), reactive power demand value (lag, lead), active power demand quantity (consumption, regeneration), reactive power demand quantity (lag, lead), power factor demand value		
Voltage range		400 V AC		
		Total display area: 5V to 520 V (less than 5 V displays as 0 V)		
		Effective measurement range: 90 V to 520 V, peak: ±750V [OVER] indicates over-range warning		
Current ranges	Load current	CLAMP ON SENSOR 9660 : 5/10/50/100 A		
		CLAMP ON SENSOR 9661 : 5/10/50/100/500 A		
		CLAMP ON SENSOR 9669 : 100/200/1k A		
		CLAMP ON SENSOR 9694 : 500m/1/5/10/50 A		
		CLAMP ON SENSOR 9695-02 : 500m/1/5/10/50 A		
		CLAMP ON SENSOR 9695-03 : 5/10/50/100 A		
		FLEXIBLE CLAMP ON SENSOR CT9667 : 50/100/500 A (500A range)		
	FLEXIBLE CLAMP ON SENSOR CT9667 : 500/1k/5k A (5000A range)			
	Leakage current	LEAK CLAMP ON SENSOR 9675 : 50m/100m/500m/1/5 A		
		LEAK CLAMP ON SENSOR 9657-10 : 50m/100m/500m/1/5 A		
		Total display range: Within 0.4 to 130% of the range (zero is suppressed for less than 0.4%)		
		Effective measurement range: Within 5 to 110% of the range [OVER] indicates over-range warning		
Power ranges		200.00 W to 6.0000 MW Depends on voltage/current combination and measured line type (see Measurement Range Configuration Tables)		
		Total display range: Within 0 to 130% of the range ("0W" display indicates zero rms voltage and/or current)		
		Effective measurement area: Within 5 to 130% of the range		
Measurement accuracy (50/60Hz)		Voltage : ±1.5% rdg. ±0.2% f.s. (combined accuracy with PW3365-20 + PW9020) Current : ±0.3% rdg. ±0.1% f.s. + clamp sensor accuracy Active power : ±2.0% rdg. ±0.3% f.s. + clamp sensor accuracy (power factor = 1)		
Calculations		RMS calculation/ fundamental wave calculation		
VT ratio settings	Any	0.01 to 9999.99	Selections	1/60/100/200/300/600/700/1000/2000/2500/5000
CT ratio settings	Any	0.01 to 9999.99	Selections	1/40/60/80/120/160/200/240/300/400/600/800/1200
Input methods		Voltage: Isolated inputs using Voltage Sensor PW9020		Current: Isolated input using a clamp-on sensor
Display update rate		Approx. 0.5 sec (except when accessing SD card or internal memory, or during LAN/USB communication)		
Measurement method		Digital sampling and zero cross synchronization calculation method Sampling: 10.24 kHz (2048 points) Calculation processing 50 Hz: Continuous, gapless measurement at 10 cycles 60 Hz: Continuous, gapless measurement at 12 cycles		
A/D converter resolution		16bit		

\*1 For individual clamp sensors' accuracy and combined accuracy figures, see pages 10 and 11.



Screen display	
List	Voltage, current, frequency, active/apparent/reactive power power factor, integrated power use, elapsed time
U/I	RMS value, fundamental wave value, waveform peak, phase angle
Power	Per-channel and total active power, apparent power, reactive power, power factor
Integ	Active energy, reactive energy, recording start time recording stop time, elapsed time, energy cost
Demand	Active power demand value, reactive power demand value power factor demand value
Waveform	Displays voltage and current waveform
Zoom	Enlarged view of 4 user-selected parameters
Trend	For one selected measurement item displays maximum, average and minimum values

Recording	
Save destination	SD Card, internal memory (capacity: approx. 320 KB)
Save interval time	1/2/5/10/15/30 seconds, 1/2/5/10/15/20/30/60 minutes Available storage time is displayed on the PW3365-20's setting screen
Save items	Measurement save : Average only/average, maximum, minimum Screen save : Saves the displayed screen as a BMP at a fixed interval*1 Waveform save : Stores binary waveform data*2
Recording start methods	Interval time, manual, or at specified time, repeat
Recording stop methods	Manual, or at specified time (up to one year), timer

\*1 The minimum interval time for saving screen copies is 5 min. If the setting is less than 5 min., screen copies will be saved every 5 min.

\*2 With shortest interval of 1 minute. When set to less than 1 minute, waveforms are saved once every minute

External interfaces	
SD card	Settings data, measurement data, screen data, waveform data
LAN	10BASE-T/100BASE-TX IEEE802.3 Compliance - HTTP server function
USB	USB Ver 2.0, Windows 8 (32/64bit)/Windows 7 (32/64bit) / Vista (32bit) / XP - When connected to a computer, the SD Card and internal memory are recognized as removable storage devices.
LAN/USB	Download settings and data using free application program

General	
Product guarantee	One year
Display	3.5 inch TFT color LCD (320 × 240 pixel)  Japanese, English, Chinese Backlight auto-off function (after 2 minutes) When AUTO OFF is active, the Power LED blinks
Operating environment	Indoors, Pollution degree 2, altitude up to 2000 m (6562-ft.)
Operating temperature and humidity (no condensation)	-10°C to 50°C (14°F to 122°F), 80% RH or less During battery operation: 0°C to 40°C (32°F to 104°F), 80% RH or less During battery charging: 10°C to 40°C (50°F to 104°F), 80% RH or less
Storage temperature and humidity (no condensation)	0°C to 60°C (32°F to 140°F), 80% RH or less However, the battery's storage temperature range is -10°C to 30°C (14°F to 86°F)
Maximum rated voltage between terminals	Voltage input section : 1.7 VAC, 2.4 Vpeak Current input section : 1.7 VAC, 2.4 Vpeak
Maximum rated voltage to earth	Voltage input section: 600V Measurement Category III 300V Measurement Category IV Current input section: Depends on clamp sensor in use.
Dielectric strength	7.06 kVrms AC
Applicable standards	Safety: EN61010, EMC: EN61326, EN61000-3-2, EN61000-3-3
Power supply	(1) Z1008 AC Adapter : 100 VAC to 240 VAC Maximum rated power : 45VA (including AC adapter) (2) Model 9459 Battery Pack : Ni-MH DC7.2 V 2700 mAh Continuous battery operation time Approx. 5 hr. Maximum rated power : 3VA
Charge function	Charge time: Max. 6 hr. 10 min. (reference value at 23°C) Charges the battery regardless of whether the instrument is on or off
Backup battery life	Clock and settings (Lithium battery), Approx. 10 years @23°C (@73.4°F)
Dimensions	Approx. 180W(7.09") × 100H(3.94") × 48D (1.89") mm (without PW9002) Approx. 180W(7.09") × 100H(3.94") × 68D (2.68") mm (with PW9002)
Mass	Approx. 540g (19 oz) (without PW9002), Approx. 820g (28.9 oz) (with PW9002)
Accessories	SAFETY VOLTAGE SENSOR PW9020 (1 set) AC ADAPTER Z1008 (1) USB cable (1) Instruction manual (1) Measurement guide (1) Color spiral tubes (1 set : red, yellow, blue/four each) Spiral tubes (10)

## POWER LOGGER VIEWER SF1001 Specifications









Functions	
Trend graph display function	Display items Voltage, current, active power, reactive power, apparent power, power factor, frequency, integrated active power, integrated reactive power, demand volume, demand value, voltage disequilibrium factor
	Stacked bar graph display : Up to 16 types of data series
Summary display function	Cursor measurements Measurement values can be displayed by the cursor
	Displayed items are the same as for the trend Graph Display
	Daily, weekly and monthly report displays: Accumulates and displays daily, weekly and monthly reports over specified period.
	Load factor calculation display: Calculates and displays load factor and demand factor results with daily, weekly and monthly reports
Waveform display	Time span aggregation: Aggregates data into up to four specified time spans
	Displays waveform data at specified date and time
Copy function	Captures any display image to the clipboard

Print function	Preview and print content shown on the trend graph, report, harmonic graph and settings displays.
	Comment entry (Text comments can be entered in any printout)
	Header/Footer settings: Sets the header and footer for each printout
Report printing	Printing support Any color or monochrome printing supported by the operating system
	Print (static) contents over a specific time period
	Output contents: Standard or selected output items
	Available output items: Trend graph, summary, daily report, waveform
Report creation method: Standard print	Report creation method: Standard print
	Report output settings: Save/load report output settings

General Specifications	
Supported models	PW3365-20 / PW3360-20 / PW3360-21
Supported computer operating systems	Windows 8 (32/64bit) Windows 7 SP1 or later (32/64bit) Windows Vista SP2 or later (32bit) Windows XP SP3 or later (32bit)

# Current CLAMP

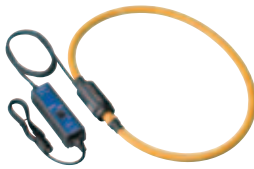

					
<b>CLAMP ON SENSOR 9694</b> Cord length 3 m (9.84ft)	<b>CLAMP ON SENSOR 9660</b> Cord length 3 m (9.84ft)	<b>CLAMP ON SENSOR 9661</b> Cord length 3 m (9.84ft)	<b>CLAMP ON SENSOR 9669</b> Cord length 3 m (9.84ft)	<b>CLAMP ON SENSOR 9695-02</b> Connect with the 9695-02/-03, Output BNC terminal Cord length: 3 m (9.84ft)	<b>CLAMP ON SENSOR 9695-03</b>  <b>CONNECTION CORD 9219</b>
<b>Measurable conductor diameter</b> φ15mm (0.59")	<b>Measurable conductor diameter</b> φ15mm (0.59")	<b>Measurable conductor diameter</b> φ46mm (0.81")	<b>Measurable conductor diameter</b> φ55mm (2.17") 80 (3.15")×20 (0.79")mm	<b>Measurable conductor diameter</b> φ15mm (0.59")	<b>Measurable conductor diameter</b> φ15mm (0.59")
<b>Primary current rating</b> 5A AC	<b>Primary current rating</b> 100A AC	<b>Primary current rating</b> 500A AC	<b>Primary current rating</b> 1000A AC	<b>Primary current rating</b> 50A AC	<b>Primary current rating</b> 100A AC
<b>Accuracy</b> Amplitude (45 to 66 Hz) / Phase (45 Hz to 5 kHz) ±0.3% rdg.±0.02% f.s. Within ±2°	<b>Accuracy</b> Amplitude (45 to 66 Hz) / Phase (45 Hz to 5 kHz) ±0.3% rdg.±0.02% f.s. Within ±1°	<b>Accuracy</b> Amplitude (45 to 66 Hz) / Phase (45 Hz to 5 kHz) ±0.3% rdg.±0.01% f.s. Within ±0.5°	<b>Accuracy</b> Amplitude (45 to 66 Hz) / Phase (45 Hz to 5 kHz) ±1.0% rdg.±0.01% f.s. Within ±1°	<b>Accuracy</b> Amplitude (45 to 66 Hz) / Phase (45 Hz to 5 kHz) ±0.3% rdg.±0.02% f.s. Within ±2°	<b>Accuracy</b> Amplitude (45 to 66 Hz) / Phase (45 Hz to 5 kHz) ±0.3% rdg.±0.02% f.s. Within ±1°
<b>Frequency characteristic</b> 40Hz to 5kHz Within ±1.0%	<b>Frequency characteristic</b> 40Hz to 5kHz Within ±1.0%	<b>Frequency characteristic</b> 40Hz to 5kHz Within ±1.0%	<b>Frequency characteristic</b> 40Hz to 5kHz Within ±2.0%	<b>Frequency characteristic</b> 40Hz to 5kHz Within ±1.0%	<b>Frequency characteristic</b> 40Hz to 5kHz Within ±1.0%
<b>Effect of external magnetic field</b> with a magnetic field of 400 A/ m AC Equivalent to 0.1 A or less	<b>Effect of external magnetic field</b> with a magnetic field of 400 A/ m AC Equivalent to 0.1 A or less	<b>Effect of external magnetic field</b> with a magnetic field of 400 A/ m AC Equivalent to 0.1 A or less	<b>Effect of external magnetic field</b> with a magnetic field of 400 A/ m AC Equivalent to 1 A or less	<b>Effect of external magnetic field</b> with a magnetic field of 400 A/ m AC Equivalent to 0.1 A or less	<b>Effect of external magnetic field</b> with a magnetic field of 400 A/ m AC Equivalent to 0.1 A or less
<b>Effect of conductor position</b> Within ±0.5%	<b>Effect of conductor position</b> Within ±0.5%	<b>Effect of conductor position</b> Within ±0.5%	<b>Effect of conductor position</b> Within ±1.5%	<b>Effect of conductor position</b> Within ±0.5%	<b>Effect of conductor position</b> Within ±0.5%
<b>Maximum rated voltage to earth</b> CAT III 300V rms	<b>Maximum rated voltage to earth</b> CAT III 300V rms	<b>Maximum rated voltage to earth</b> CAT III 600V rms	<b>Maximum rated voltage to earth</b> CAT III 600V rms	<b>Maximum rated voltage to earth</b> CAT III 300V rms	<b>Maximum rated voltage to earth</b> CAT III 300V rms
<b>Maximum input</b> 45-66Hz 50A continuous	<b>Maximum input</b> 45-66Hz 130A continuous	<b>Maximum input</b> 45-66Hz 550A continuous	<b>Maximum input</b> 45-66Hz 1000A continuous	<b>Maximum input</b> 45-66Hz 60A continuous	<b>Maximum input</b> 45-66Hz 130A continuous
<b>Dimensions / Mass</b> 46W × 135H × 21D mm / 230g (1.81") × (5.31") × (0.83") / (8.1 oz)	<b>Dimensions / Mass</b> 46W × 135H × 21D mm / 230g (1.81") × (5.31") × (0.83") / (8.1 oz)	<b>Dimensions / Mass</b> 77W × 151H × 42D mm / 380g (3.03") × (5.94") × (1.65") / (13.4 oz)	<b>Dimensions / Mass</b> 99.5W × 188H × 42D mm / 590g (3.92") × (7.40") × (1.65") / (20.8 oz)	<b>Dimensions / Mass</b> 50.5W × 58H × 18.7D mm / 50g (2.28") × (2.28") × (0.74") / (1.8 oz)	<b>Dimensions / Mass</b> 50.5W × 58H × 18.7D mm / 50g (2.28") × (2.28") × (0.74") / (1.8 oz)
					
<b>FLEXIBLE CLAMP ON SENSOR CT9667</b> Cord length Sensor - circuit: 2 m (6.56ft) Circuit - connector: 1 m (3.28ft)	<b>CLAMP ON LEAK SENSOR 9657-10</b> Leakage Current Measurement Only Cord length : 3 m (9.84ft)	<b>CLAMP ON LEAK SENSOR 9675</b> Leakage Current Measurement Only Cord length : 3 m (9.84ft)			
<b>Measurable conductor diameter</b> φ254mm	<b>Measurable conductor diameter</b> φ40mm	<b>Measurable conductor diameter</b> φ30mm			
<b>Primary current rating</b> AC500A/ AC5000A	<b>Primary current rating</b> AC10A*	<b>Primary current rating</b> AC10A*			
<b>Accuracy</b> 45-66Hz ±2.0% rdg ± 0.3% f.s. / Within ±1°	<b>Accuracy</b> ±1.0% rdg ±0.05% f.s. / Within ±3°	<b>Accuracy</b> ±1.0% rdg ±0.05% f.s. / Within ±5°			
<b>Frequency</b> 10-20kHz Within ± 3dB	<b>Frequency</b> 40 - 5kHz Within ± 5%	<b>Frequency</b> Within ± 5%			
<b>Effect of external magnetic field</b> 1.5% / f.s. or less	<b>Effect of external magnetic field</b> 7.5mA max.	<b>Effect of external magnetic field</b> 7.5mA max.			
<b>Effect of conductor position</b> Within ± 3%	<b>Effect of conductor position</b> Within ±0.1%	<b>Effect of conductor position</b> Within ±0.1%			
<b>Maximum rated voltage to earth</b> CAT III 1000V rms / CAT IV 600V rms	<b>Maximum rated voltage to earth</b> CAT III 300V rms	<b>Maximum rated voltage to earth</b> CAT III 300V rms			
<b>Maximum input</b> 45-66Hz 10000A continuous	<b>Maximum input</b> 45-66Hz 30A continuous	<b>Maximum input</b> 10A continuous			
<b>Dimensions / Mass</b> Circuit box: 35W×120.5H×34D/470g	<b>Dimensions / Mass</b> 74W× 145H × 42D / 380g	<b>Dimensions / Mass</b> 60W× 112.5H × 23.6D / 160g			
<b>Power supply</b> LR06 alkaline battery × 2 or AC ADAPTER 9445-02/9445-03 (optional)	<b>Notes</b> Not used for power measurements *Maximum AC measurement range with PW3365-20 is 5A	<b>Notes</b> Not used for power measurements *Maximum AC measurement range with PW3365-20 is 5A			

## Measurement Range Configurations

CLAMP ON SENSOR 9694 / 9695-02 *1						
Voltage	Connection	Current				
		500.00mA	1.0000A	5.0000A	10.000A	50.000A
400.0V	1P2W	200.00W	400.00W	2.0000kW	4.0000kW	20.000kW
	1P3W 1P3W1U 3P3W2M 3P3W3M	400.00W	800.00W	4.0000kW	8.0000kW	40.000kW
	3P4W	600.00W	1.2000kW	6.0000kW	12.000kW	60.000kW

CLAMP ON SENSOR 9660 / 9695-03 / 9661*2						
Voltage	Connection	Current				9661only 500.00A
		5.0000A	10.000A	50.000A	100.00A	
400.0V	1P2W	2.0000kW	4.0000kW	20.000kW	40.000kW	200.00kW
	1P3W 1P3W1U 3P3W2M 3P3W3M	4.0000kW	8.0000kW	40.000kW	80.000kW	400.00kW
	3P4W	6.0000kW	12.000kW	60.000kW	120.00kW	600.00kW

CLAMP ON SENSOR 9669				
Voltage	Connection	Current		
		100.00A	200.00A	1.0000kA
400.0V	1P2W	40.000kW	80.000kW	400.00kW
	1P3W 1P3W1U 3P3W2M 3P3W3M	80.000kW	160.00kW	800.00kW
	3P4W	120.00kW	240.00kW	1.2000MW

FLEXIBLE CLAMP ON SENSOR CT9667 (CT9667-5kA)				
Voltage	Connection	Current		
		500.00A	1.0000kA	5.0000kA
400.0V	1P2W	200.00kW	400.00kW	2.0000MW
	1P3W 1P3W1U 3P3W2M 3P3W3M	400.00kW	800.00kW	4.0000MW
	3P4W	600.00kW	1.2000MW	6.0000MW

FLEXIBLE CLAMP ON SENSOR CT9667 (CT9667-500A)				
Voltage	Connection	Current		
		50.00A	100.00A	500.00A
400.0V	1P2W	20.000kW	40.000kW	200.00kW
	1P3W 1P3W1U 3P3W2M 3P3W3M	40.000kW	80.000kW	400.00kW
	3P4W	60.000kW	120.00kW	600.00kW

Leak current: CLAMP ON LEAK SENSOR 9657-10, 9675	
Range	50.000mA / 100.00mA / 500.00mA / 1.0000A / 5.0000A

## Combined Accuracy PW3365-20 + PW9020 + clamp sensors

Range	9694	9695-02
50.000A	-	±2.3% rdg. ±0.32% f.s.
10.000A	-	±2.3% rdg. ±0.4% f.s.
5.0000A	±2.3% rdg. ±0.32% f.s.	±2.3% rdg. ±0.5% f.s.
1.0000A	±2.3% rdg. ±0.4% f.s.	±2.3% rdg. ±1.3% f.s.
500.00mA	±2.3% rdg. ±0.5% f.s.	±2.3% rdg. ±2.3% f.s.

Range	9660, 9695-03	9661
500.00A	-	±2.3% rdg. ±0.31% f.s.
100.00A	±2.3% rdg. ±0.32% f.s.	±2.3% rdg. ±0.35% f.s.
50.000A	±2.3% rdg. ±0.34% f.s.	±2.3% rdg. ±0.4% f.s.
10.000A	±2.3% rdg. ±0.5% f.s.	±2.3% rdg. ±0.8% f.s.
5.0000A	±2.3% rdg. ±0.7% f.s.	±2.3% rdg. ±1.3% f.s.

Range	9669
1.0000kA	±3% rdg. ±0.31% f.s.
200.00A	±3% rdg. ±0.35% f.s.
100.00A	±3% rdg. ±0.4% f.s.

Range	CT9667 5.000kA range	CT9667 500A range
5.0000kA	±4% rdg. ±0.6% f.s.	-
1.0000kA	±4% rdg. ±1.8% f.s.	-
500.00A	±4% rdg. ±3.3% f.s.	±4% rdg. ±0.6% f.s.
100.00A	-	±4% rdg. ±1.8% f.s.
50.000A	-	±4% rdg. ±3.3% f.s.

Conditions of guaranteed accuracy	After 30 minute warm-up, with 50/60 Hz sine wave input voltage to earth 400V or less
Temperature and humidity for guaranteed accuracy	23°C ±5°C (73 ± 9°F), 80%RH or less (applies to all specifications unless otherwise noted)
Display area of guaranteed accuracy	Effective measurement range
Period of guaranteed accuracy	1 year
Real-time clock accuracy	Within ±0.3 sec/day (with power on, within specified operating temperature and humidity ranges)
Temperature characteristic	Within ±0.1% f.s./°C (except 23 ±5°C)
Effect of external magnetic field	Within ±1.5% f.s. (in a magnetic field of 400 A/m rms AC, 50/60 Hz)
Effect of radiated, radio-frequency, electromagnetic field	Within ±5% f.s. for voltage and active power at 10 V/m
Apparent power	±1 dgt. for the calculation obtained from each measurement value
Reactive power	Fundamental waveform calculations ±2.0% rdg. ±3.0% f.s. + clamp-on sensor accuracy (w/power factor = 1)
	Rms calculations From each measurement applied to calculation ±1 dgt.
Energy	Active and reactive power measurement accuracies ±1 dgt.
Power factor	From each measurement applied to calculation ±1 dgt.
Frequency	±0.5% rdg. (with 90 to 520 V sine wave input)
Demand value	Active and reactive power measurement accuracies ±1 dgt.
Demand quantity	Active and reactive power measurement accuracies ±1 dgt.

\*1 For the 9694 sensor, the range of guaranteed accuracy is from 500 mA to 5 A, and for the 9695-02, from 500 mA to 50 A.

\*2 For the 9660 and 9695-03 sensors, the range of guaranteed accuracy is from 5 A to 100 A and for the 9661, from 5 A to 500 A.

## Current Display and Effective Measurement Ranges

typical

	Range	Total display range	Effective measurement range		Total display range	Effective peak
		Minimum	Minimum	Maximum	Maximum	Range
Voltage	400V Range	5.0V	90.0V	520.0V	520.0V	±750Vpeak
Current	5A Range	0.0200A	0.2500A	5.5000A	6.5000A	±20Apeak
	10A Range	0.040A	0.500A	11.000A	13.000A	±40Apeak
	50A Range	0.200A	2.500A	55.000A	65.000A	±200Apeak
	100A Range	0.40A	5.00A	110.00A	130.00A	±400Apeak
	500A Range	2.00A	25.00A	550.00A	650.00A	±1000Apeak



# CLAMP ON POWER LOGGER PW3365-20

## Accessories

SAFETY VOLTAGE SENSOR PW9020 (1 set)	Instruction manual (1)
AC ADAPTER Z1008 (1)	Measurement guide (1)
USB cable (1)	Color spiral tubes (1 set : red, yellow, blue/four each)
	Spiral tubes (10)



Clamp On Power Logger PW3365-20 by itself does not support current and power measurements. Current and power measurements require clamp on sensors, sold separately. Use only HIOKI SD cards guaranteed to work for saving measurement data (options, sold separately).

## Options

### CLAMP ON SENSOR (for load current measurement)

CLAMP ON SENSOR	9694	(AC5A)
CLAMP ON SENSOR	9660	(AC100A)
CLAMP ON SENSOR	9661	(AC500A)
CLAMP ON SENSOR	9669	(AC1000A)
FLEXIBLE CLAMP ON SENSOR	CT9667	(AC5000A)
CLAMP ON SENSOR *	9695-02	(AC50A)
CLAMP ON SENSOR *	9695-03	(AC100A)
CONNECTION CORD	9219	(for connection to 9695-02, 9695-03)

\* When purchasing the 9695-02 and 9695-03, we recommend also purchasing the separately sold 9219 Connection Cord.

### CLAMP ON ADAPTER 9290-10

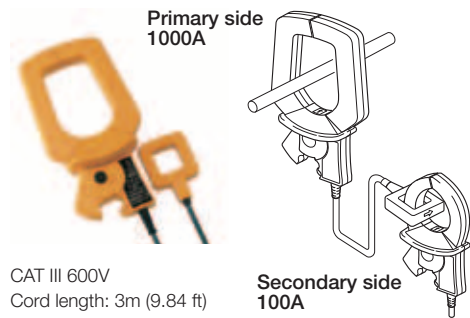

### CLAMP ON LEAK SENSOR (for leakage current measurement)

CLAMP ON LEAK SENSOR	9657-10
CLAMP ON LEAK SENSOR	9675

### Measurable conductor diameter

φ55 mm (2.17in)  
Bus bar : 80 mm (3.46in) 5 20 mm (0.79 in)  
CT ratio : 10:1  
MAX. 1500A AC (continuous: 1000A)

### POWER LOGGER VIEWER SF1001

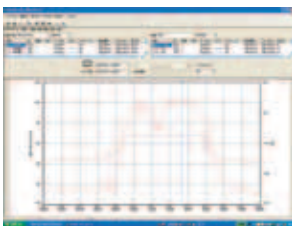

#### Supported computer operating systems

Windows 8 (32/64bit)  
Windows 7 SP1 or later (32/64bit)  
Windows Vista SP2 or later (32bit)  
Windows XP SP3 or later (32bit)

Trend graph display function  
Summary display function  
Waveform display  
Print function  
Report printing

### BATTERY SET PW9002

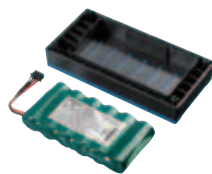

Battery Case and Battery Pack Set

#### BATTERY PACK 9459

For purchase as replacement battery pack

### SAFETY VOLTAGE SENSOR PW9020



PW3365-20 is bundled with 4 sensors  
Additional single sensors also available  
Cord length: 3m (9.84 ft)

### CARRYING CASE C1005/C1008



<b>C1005</b>	<b>C1008</b>
Dimension : 390 W (15.4")	390 W (15.4")
(Approx) 275 H (10.8")	275 H (10.8")
110 D (4.3") mm	150 D (5.9") mm

### AC ADAPTER Z1008



Includes standard  
For separate purchase

### SD MEMORY CARD 2GB Z4001



Stores up to one year's data when acquired at one minute intervals. Performance cannot be guaranteed on storage media other than Hioki-specified SD card options.

### LAN CABLE 9642



Note: Company names and Product names appearing in this catalog are trademarks or registered trademarks of various companies.

# HIOKI

HIOKI E. E. CORPORATION

#### HEADQUARTERS:

81 Koizumi, Ueda, Nagano, 386-1192, Japan  
TEL +81-268-28-0562 FAX +81-268-28-0568  
http://www.hioki.com / E-mail: os-com@hioki.co.jp

#### HIOKI USA CORPORATION:

TEL +1-609-409-9109 FAX +1-609-409-9108  
http://www.hiokiusa.com / E-mail: hioki@hiokiusa.com

#### HIOKI (Shanghai) SALES & TRADING CO., LTD.:

TEL +86-21-63910090 FAX +86-21-63910360  
http://www.hioki.cn / E-mail: info@hioki.com.cn

#### HIOKI INDIA PRIVATE LIMITED:

TEL +91-124-6590210 FAX +91-124-6460113  
E-mail: hioki@hioki.in

#### HIOKI SINGAPORE PTE. LTD.:

TEL +65-6634-7677 FAX +65-6634-7477  
E-mail: info-sg@hioki.com.sg

#### HIOKI KOREA CO., LTD.:

TEL +82-42-936-1281 FAX +82-42-936-1284  
E-mail: info-kr@hioki.co.jp

DISTRIBUTED BY