



NOISE HILOGGER 3145-20 NOISE SEARCH TESTER 3144-20

Optical and Network Measurement Instruments



For support the Investigation and the measures of the noise disorder

- **Specially designed for on-site noise measurements**
Locate and develop countermeasures against noise interference
- **Non-contact measurements for simplicity and safety**
Measure noise on active power, telecom and ground lines without interruption
- **Capture even one-shot noise**
Measure lightning surges, contact opening/closing surges and ESD noise



ISO 9001
JMI-0216



ISO14001
JQA-E-90091



www.hioki.com

HIOKI company overview, new products, environmental considerations and other information are available on our website.

Have you ever had a problem with electronic device faults and telecommunications interference?

Device malfunctions

Device damage

Network connection problems

Slow data communications, etc.

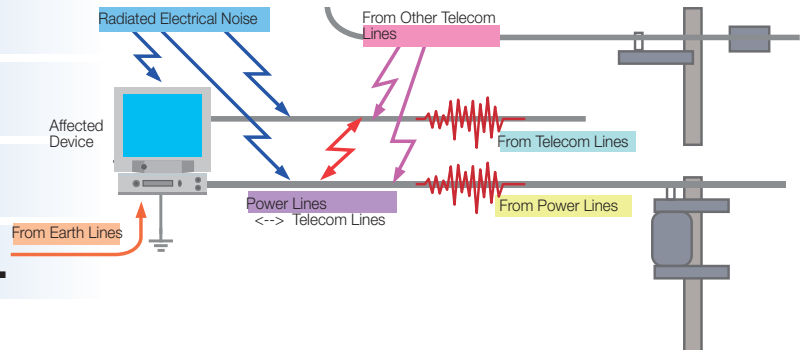

How do you know if the noise ingress is from the device's power, telecom or earth line? HIOKI's series of noise measurement instruments are designed to help your investigation.

Optimal frequency range for measuring conducted noise

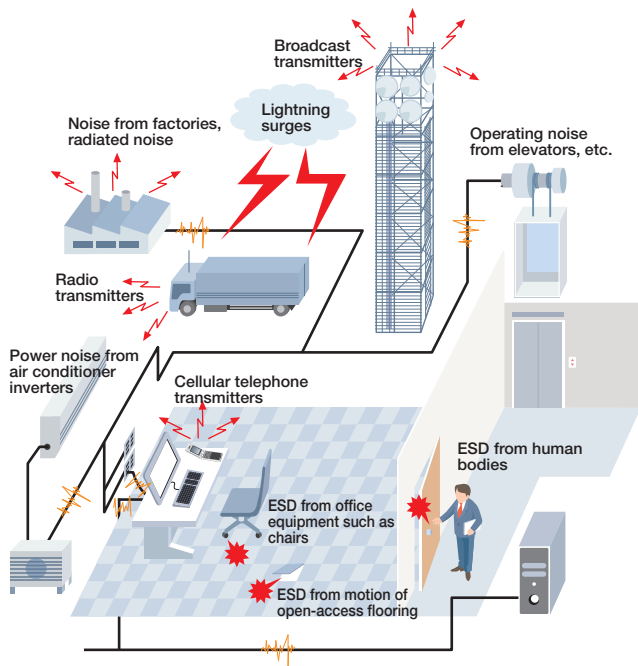

Broad Measurement Frequency Range

10 kHz to 100 MHz (Model 3145-20)
500 Hz to 30 MHz (Model 3144-20)

Check for broad ranges of noise at one time: Model 3145-20 measures noise between 10 kHz and 100 MHz, and Model 3144-20 measures noise between 500 Hz and 30 MHz.

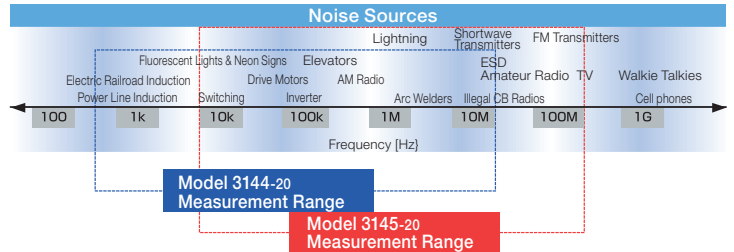

Clamp-Type Noise Sensor (Non-Contact)

Detect noise without contact, and earth-free (Model 9754). Because measurement requires no electrical contact, there's no need to worry about interfering with communications, electric shock or short circuits, and use is simple and safe even in active-line conditions.

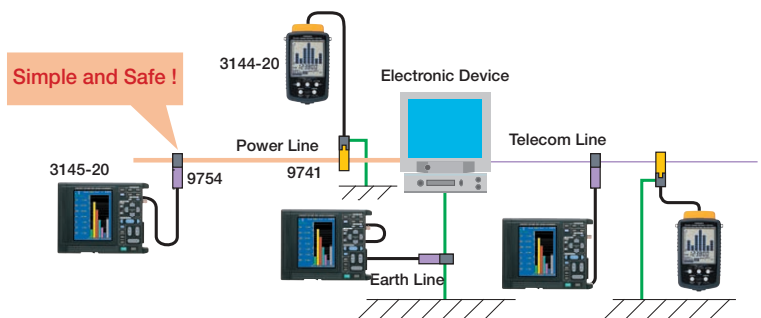

The Clamp-On Noise Sensor 9754 detects noise current, and the Clamp-On Voltage Sensor 9741 detects noise voltage. Measure noise just by clamping around telecom, power and earth lines. (The Clamp-On Voltage Sensor 9741 requires grounding)

Easily measure earth line noise

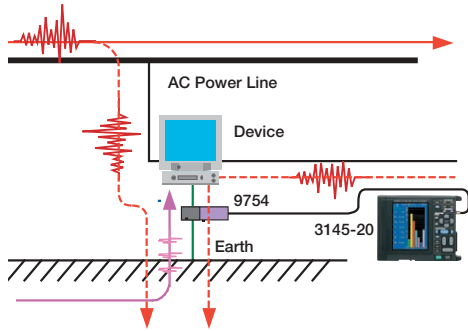

The impedance of an earth line is proportional to its length and frequency. **When noise current flows in an earth line**, the resulting noise voltage may swing the potential of an electronic device **to cause noise interference**.

Using the NOISE HiLOGGER 3145-20 with the Clamp-On Noise Sensor 9754, the noise current level and frequency of the earth line can be measured simply, without direct contact.

Reliably capture one-shot noise

One-shot noise such as from lightning surges, contact opening/closing surges and electrostatic discharges **is captured using the peak-detection function (Model 3145-20)**.

With a spectrum analyzer One-shot noise cannot be reliably detected while sweeping the measurement range at a particular sweep frequency.

With FFT functions One-shot noise that occurs during the dead time cannot be detected with an FFT analysis function of a digital oscilloscope.

With the NOISE HiLOGGER 3145-20 The 3145-20 is designed to measure noise that changes frequency or level over time, as well as one-shot noises such as surges.

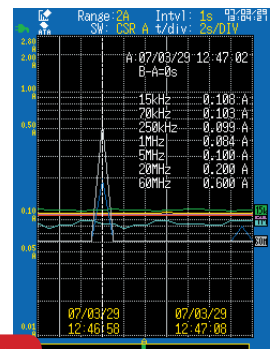
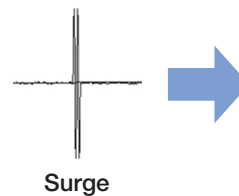

High-end functionality in Model 3145-20, or the compact light weight Model 3144-20

Choose the model to suit your application

No.	Application	3145-20 (High-End Functionality) pp. 3 to 7	Model 3144-20 (Simple and Economical) P.8
1	Measuring earth line noise	Clamp-only, earth-free connection See p. 2	Grounding required See p. 1
2	Measuring surge and electrostatic noise	Peak detection of one-shot noise See p. 2	—
3	Measuring noise on power and telecom lines	Frequency range from inverters to FM transmissions (10 kHz to 100 MHz) See p. 1	Frequency range from power systems to CB transmissions (500 Hz to 30 MHz) See p. 1
4	Recording noise level fluctuations	Logging function Long-term storage on memory card Time-series graph display See p. 4	Records to internal memory View time-series graphs with supplied PC application program See p. 8
5	Compare noise levels	Settable noise level threshold See p. 4	—
6	Determining when noise events occur	Alarm function See p. 4	—
7	Measuring and monitoring remote sites	Remote control via LAN E-mail sending function See p. 5	—
8	Analyzing results on a personal computer	PC application program supplied See p. 6	Supplied PC application program See p. 8
9	Measurements that require portability	90-minute rechargeable batteries High-end functionality and light weight See pp. 4 to 9	Runs for five hours on six alkaline AA batteries Compact and light-weight See pp. 8 to 10

Measuring Noise Current and Noise Voltage Noise current: Measure using the Model 9754 Clamp-On Noise Sensor (option for Model 3145-20). Noise voltage: Measure using the Model 9741 Clamp-On Noise Sensor (supplied with Model 3144-20). Noise current and voltage measurements have the following features.

Noise current measurement
The 9754 sensor (option for Model 3145-20) measures noise current. Noise current measurement is ideal for determining the noise propagation route from the point of ingress, and for measuring earth line noise. Measurement with the 9754 is earth-free (no grounding required).

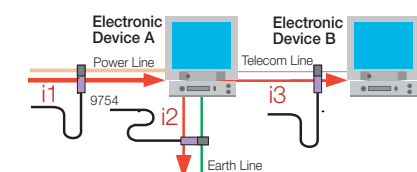

From $i1 = i2 + i3$
Noise current ingress on a power line can flow through electronic device A to appear on the earth and telecom lines.

Noise voltage measurement
Electronic devices normally operate at a specific voltage level. Noise voltage measurement can determine whether noise is the cause of damage from exceeding a safe threshold or of malfunction due to inadequate noise margin. The 9741 Sensor (supplied with Model 3144-20) measures noise voltage. Noise voltage measurement with the 9741 requires grounding to establish a reference potential.

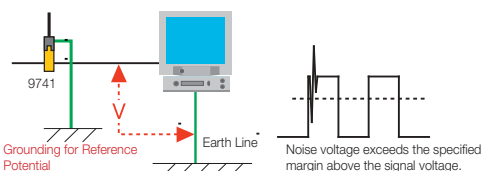

Noise voltage is proportional to the impedance at the location of ingress.

Some other specifications differ for the two models, so please select a model according to your application.

Comparison of Sensor Models 9754 and 9741

Measured Parameter	CLAMP ON NOISE SENSOR 9754	CLAMP ON VOLTAGE SENSOR 9741
Grounding	No	Required
Conductor position effect error	Small	Large
Conductor diameter effect error	Small	Large
Maximum clamping diameter	20 mm	20 mm
Max. rated voltage to earth	CAT II 600 V CAT III 300 V	CAT III 200V

NOISE HiLOGGER 3145-20

High-end functionality noise measurement instrument provides long-term recording and remote control functions

Color LCD Noise Level Display

View instantaneous values of measured noise, and noise level variations over time.

LAN Connector (10BASE-T)

PC Card

BNC Jack
For the CLAMP ON NOISE SENSOR 9754 or other voltage input (from antenna or short-range magnetic probe).

○ Current Ranges (using Model 9754 Sensor)	
200 mA range	2.0 mAp-p to 280.0 mAp-p
2 A range	0.020 Ap-p to 2.800 Ap-p
20 A range	0.20 Ap-p to 28.00 Ap-p
○ Voltage Ranges	
10 mV range	0.20 mVp-p to 14.00 mVp-p
100 mV range	2.0 mVp-p to 140.0 mVp-p
1 V range	0.020 Vp-p to 1.400 Vp-p

CLAMP ON NOISE SENSOR 9754 (Option)
Measure noise current without direct connection

Monitoring Measurement

View instantaneous noise levels in a bar graph



The 3145-20 separates noise between 10 kHz and 100 MHz into seven frequency bands, and displays the noise current level of each band as one bar in a bar graph, which is refreshed every 100 ms.

Just clamp around a signal line and start measuring immediately.

Seven Band-Pass Filters Separate Noise

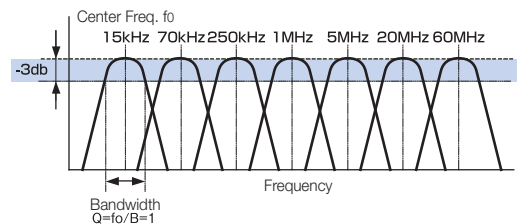

Monitoring on an oscilloscope

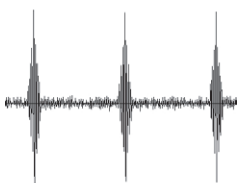

Noise waveform details can be measured, but the kind of noise cannot be determined.

Noise levels are displayed in a bar graph on the 3145-20

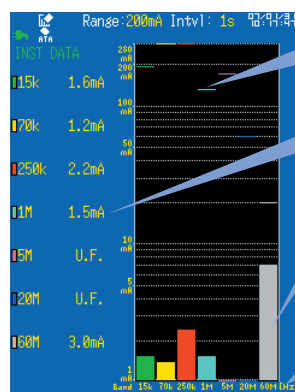

- Peak Bar**
Peak Noise Level
- Numerical Display**
View Instantaneous or Maximum Values
- Level Bar**
Present Noise Level
- Bands**
Displays Seven Frequency Ranges

Easily view the noise current level in each band.
The displayed bar graph exposes the characteristics of the noise.

Logging Measurement

Record noise level variations over time

Variations in the noise levels of the seven frequency bands over time are recorded in the instrument's internal memory. By analyzing logged data, long-term and periodic noise levels can be captured and the timing of the noise occurrence can be determined. The recording interval can be set from 1 to 60 seconds. The peak level of noise measured within each recording interval is recorded.

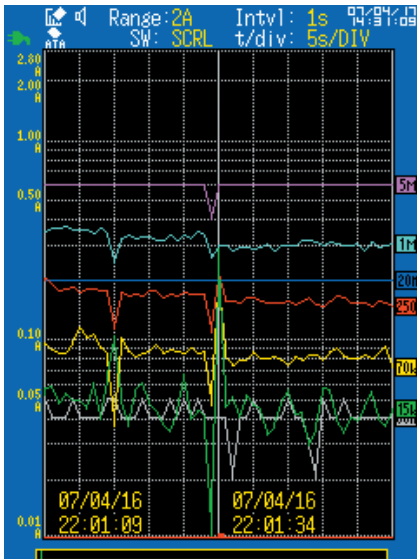

The noise level of each frequency band saved in the instrument's internal memory is displayed as a time series.

Past noise levels can be viewed using the Waveform Scroll function.

Automatically save data to a memory card while measuring

Measurement data can be automatically saved to a PC Card. For continuous long-term recording, cards up to 1 GB are supported. Data saved to a PC Card can be analyzed on a personal computer using the supplied DATA VIEWER program for Model 3145-20.

■ Intended Recording Time

Recording Interval	1 s	2 s	5 s	10 s	20 s	30 s	60 s
Internal Memory	16 days	1 month	2.5 months	5 months	10 months	15 months	2.5 years
Using a PC Card (128 MB)	2 months	4 months	10 months	1.5 years	3.3 years	5 years	10 years

Note: Recording times are calculated values, and cannot be guaranteed.

● Charge the battery pack while operating (with Battery Pack Model 9447)

The battery charges while measuring. If an unexpected power outage occurs during long-term recording, measurement continues on battery power, greatly improving the reliability of long-term measurements.

What happens when power is lost while measuring?

- If no battery pack is available for power backup, measuring is interrupted and data in the instrument's memory is lost after about ten minutes.
- If Auto Save is enabled when using a PC Card, data measured up to one minute before a power outage is saved on the PC Card.
- Recovery to the pre-outage state is available with the Start Backup function.

Alarm Function

An alarm sounds when the noise level exceeds a specified threshold

Using the Alarm Function

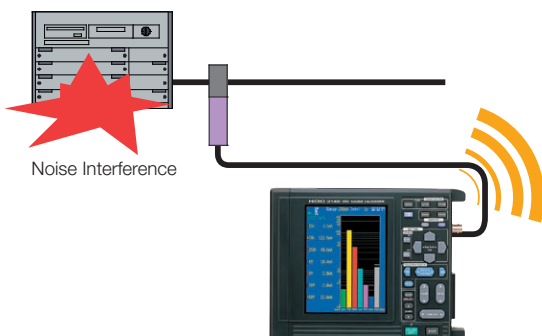

Noise occurrences can be quickly discovered by setting the alarm threshold at the ambient noise level during normal conditions.

While logging measurements, the date and time of alarm events are recorded, so you can see precisely when rare noise interference events occur.

The e-mail notification function sends an e-mail to an office PC or cell phone when the noise at a remote location triggers an alarm event.

Note: a LAN environment is necessary for e-mail.

Communication Function

Remote Operation (Remote Measurement via HTTP Server)

The instrument's settings, data acquisition and screen monitoring can be controlled via an Internet browser such as Internet Explorer.

- REMOTE CONTROL
- DATA GET BY FTP
- START/STOP
- CURRENT DATA DISP
- MEMORY DATA GET
- COMMENT SET

[Connection Example Using HTTP Communication via 10BASE-T LAN]

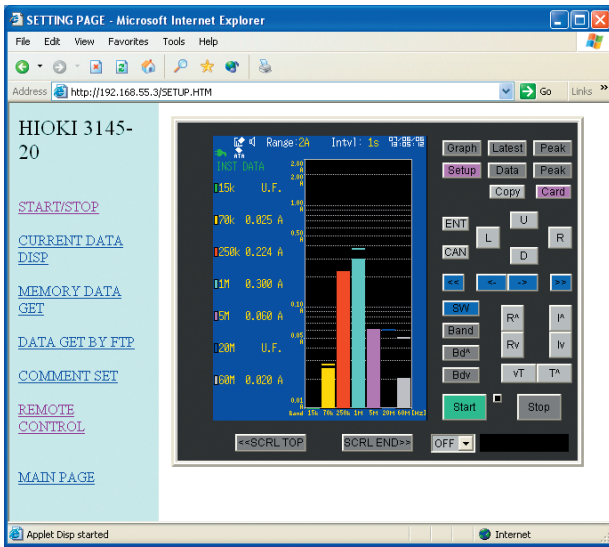
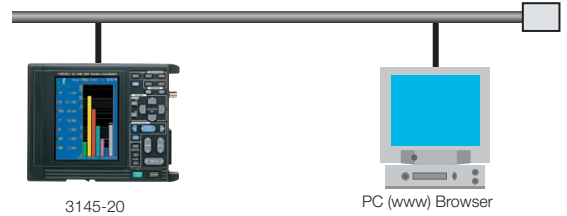

Remote Operating Screen

- The browser displays a working emulation of instrument's control panel.
- Keys on the emulated panel work just like those on the instrument.

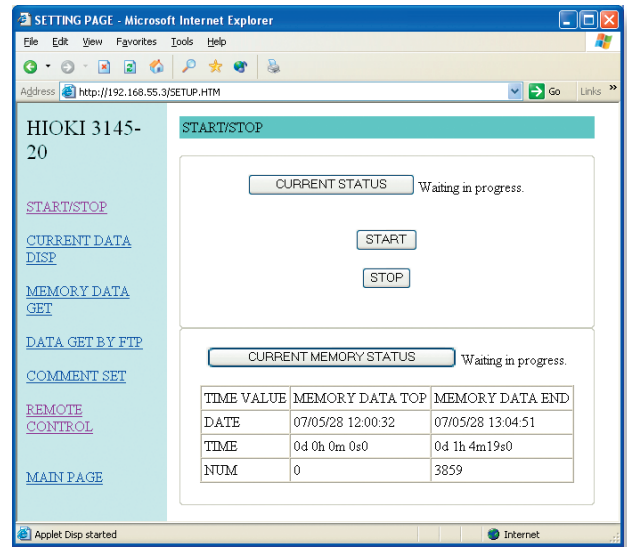

Starting and Stopping Measurement

- Start and stop measurement from your web browser.
- Real-time measurement conditions are displayed.

Communication Function

E-Mail Sending

An e-mail can be sent to a PC in a local network or located remotely when measurement stops, an alarm occurs, upon recovery from power outage, or when internal memory or a PC Card becomes full.

[Connection Example Using Mail send via 10BASE-T LAN]

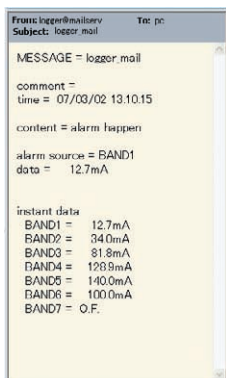
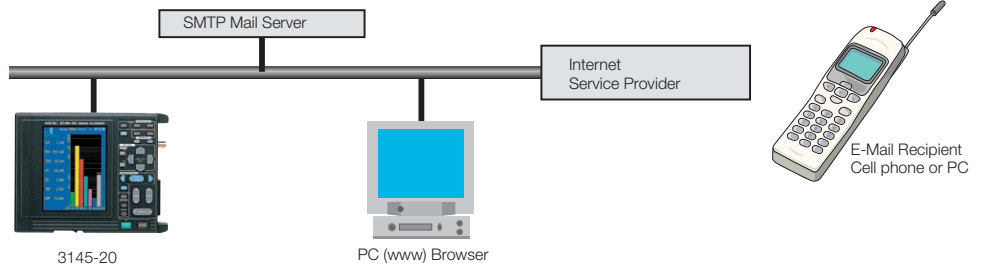

[E-Mail Example]

PC Application Program: DATA VIEWER for the 3145-20

This program allows data logged by the NOISE HILOGGER to be viewed on a PC.

Additional functions include searching measurement data according to specified criteria, time-series graph printing and converting measurement data to CSV format.

Operating environment

- Compatible OS: Windows 2000, XP, Vista, 7 (64-bit support limited to Windows 7) For system environment settings such as CPU, memory and display, use an environment which conforms to that recommended by your OS.
- HDD space: 10 MB or more of free disk space

Converting to CSV Format
Data can be converted to text in CSV format for importing by spreadsheet programs

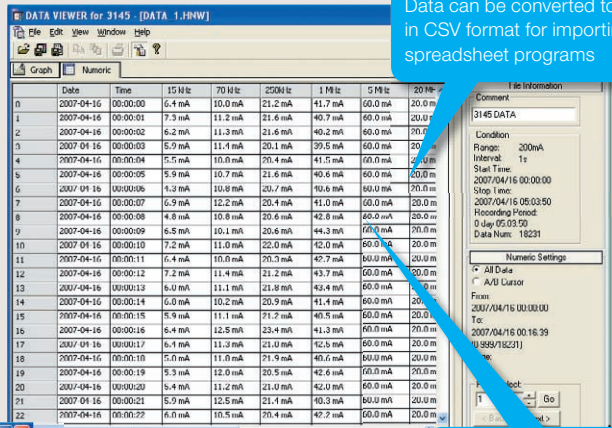

Graph Display
Graphically displays recorded measurement data as a time series

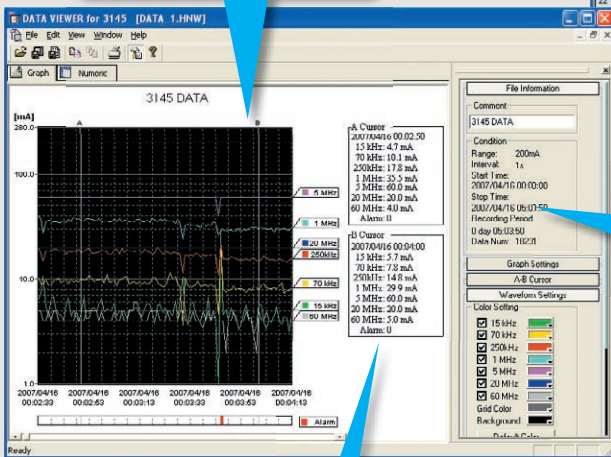

Cursor Function
Displays the time and measurement values at A/B cursor positions

Numerical Value Display
Displays the numerical values of recorded measurement data

Measurement Data Searching
Search criteria: current level, alarm level and peak level events can be specified and searched

Day Display Example

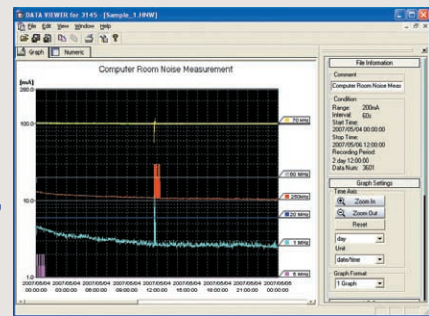

By viewing data in a Day Display, noise variations throughout the day can be seen at a glance.

Printing and Report Generation

Print measurement data as a time-series graph.

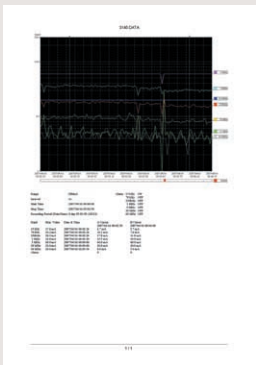

Capture an image of the displayed graph and copy it into Word or other programs.

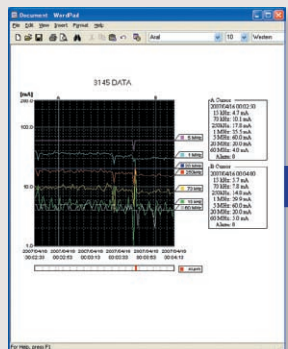

Paste an image of the displayed graph into other programs when generating reports

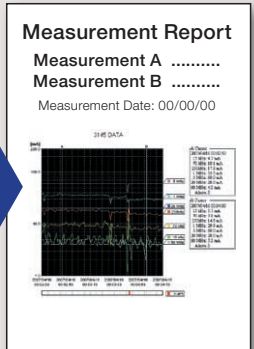

Print from the Application Program

Noise Measurement Example Using the Monitor Function

To investigate computer malfunctions, measure the noise current on a LAN cable using the NOISE HILOGGER 3145-20.

Clamp the CLAMP ON NOISE SENSOR 9754 around the LAN cable and monitor the NOISE HILOGGER display.

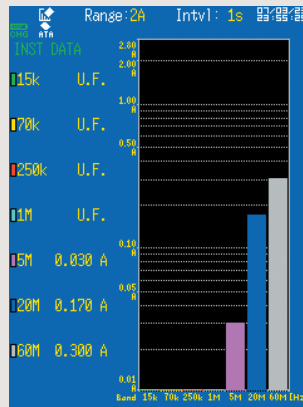

← Large noise ingress can be seen around 60 and 20 MHz.

Install noise suppression and recheck the noise current level on the 3145-20's monitor.

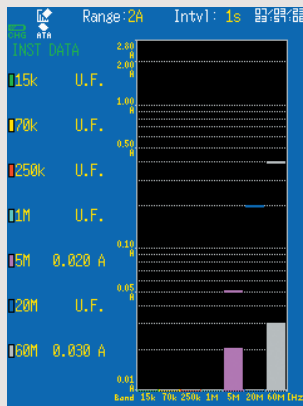
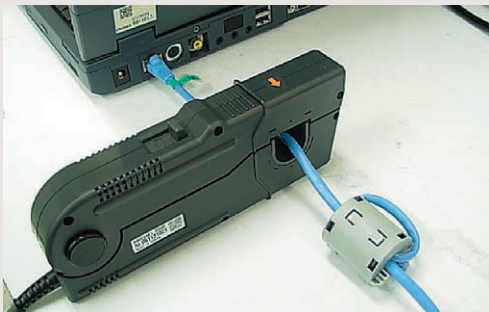

← **Results**

The effectiveness of the noise suppression is obvious.

Noise Measurement Example using the Logging Function

Electronic device malfunctions sometimes occur intermittently.

Although noise is a likely cause, it may be difficult to confirm with the monitor function if it is intermittent.

We could capture the noise waveform using the trigger function of an oscilloscope, but that doesn't give much information about the frequency and level of the noise, so the trigger settings may not be useful.



Use the logging function.

One-shot noise that occurs intermittently can be captured by the Peak Detection function. Once the frequency and level of the noise that causes the malfunction are known, appropriate noise suppression steps can be taken.

The time needed to resolve noise interference problems can be shortened.

Select the measurement range and recording interval, and start logging.

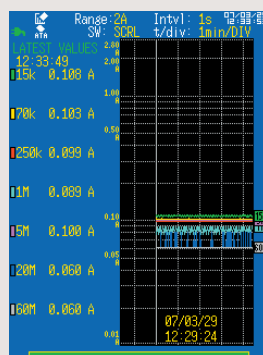

The noise level is constant and no device malfunctions occur.

Measurement Range Selection
Begin with the following settings:
Telecom Line: 200 mA range
Power and Earth Lines: 2 A range
Lightning Surges: 20 A range

An electronic device malfunction occurred.

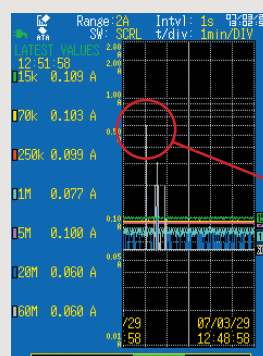

The characteristics of the noise and time of malfunction are indicated on the 3145-20's Logging screen.

At the time of the device malfunction, a fluctuation in the 60 MHz noise level is evident.
Nominal level: 0.060 A

↓
Level at the time of malfunction: 0.600 A
The noise level becomes ten times greater.

NOISE SEARCH TESTER Model 3144-20

Compact, light weight noise measurement tool handles like a hand-held tester

Features



- **Non-contact voltage sensor**
Find noise in active circuits without disrupting signals or damaging cables.
- **Measures from 500 Hz to 30 MHz**
Covers a broad frequency range, from power line noise to CB transmitters.
- **Level meter display on a large LCD**
Noise is detected and displayed separately for each frequency band.
- **Peak-Hold function**
Displays the peak voltage and its measurement time in each frequency band.
- **Logging function for long-term monitoring**
Records up to 64,000 measurement points (levels and times).
- **USB interface included**
With the supplied PC application program, transfer data to a PC, display time-series data and output to a printer.
- **Powered by battery or AC adapter**
Supports both portable on-site measurements and long-term monitoring.

On-Site Measurement Monitor Function

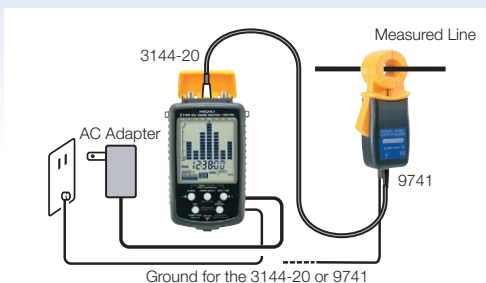

The Noise Search Tester measures noise from 500 Hz to 30 MHz in seven bands, and displays the noise voltage in each band as one of seven bars on the level meter. Measurement is performed just by clamping the CLAMP ON VOLTAGE SENSOR 9741 around the line of interest. Noise levels can thus be monitored easily in the active-line state, without removing insulation.

Record to Internal Memory Logging Function

Measured levels and times are stored in internal memory at the specified recording interval. Two recording modes can be selected from the following:

Auto-Stop Mode

Recording stops when internal memory becomes full.

Use this mode to retain all data recorded during the measurement period.

Overwrite Mode

Recording continues, overwriting the oldest data. By measuring in this mode continuously, the important data is captured whenever an anomaly occurs.

The Peak-Hold function displays the peak values and times of occurrence in each frequency band.

Internal Memory Recording Time

Recording Interval	Auto-Stop Mode	Overwriting (CONT) Mode
	Longest Recording Duration	Minimum Guaranteed Recording Duration
1 s	17.7 h	15.5 h
2 s	1.4 days	1.2 days
5 s	3.7 days	3.2 days
10 s	7.4 days	6.4 days
20 s	14.8 days	12.9 days
30 s	22.2 days	19.4 days
1 min	1.4 mos	1.2 mos
2 min	2.8 mos	2.5 mos
5 min	7.1 mos	6.2 mos
10 min	1.1 years	1.0 years
20 min	2.3 years	2.0 years
30 min	3.5 years	3.1 years
60 min	7.1 years	6.2 years

Note: Recording times are calculated values, and cannot be guaranteed.

Analyzing Recorded Data on a PC Bundled Application Program

The supplied PC program quickly transfers recorded data from the Tester to a PC. Measured noise levels and times can be viewed on a graph, saved as BMP files and printed, for use in generating reports.

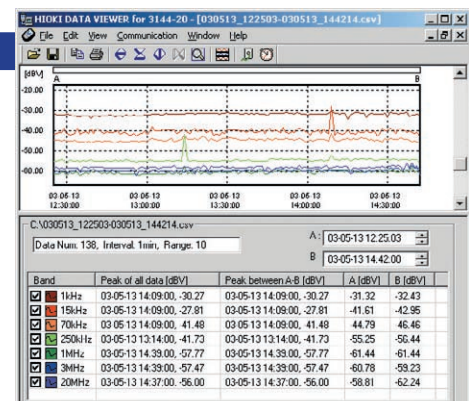
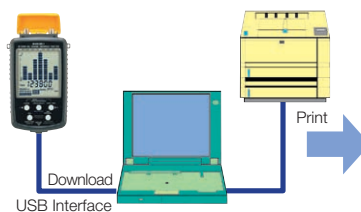

Operating environment

- Compatible OS: Windows 2000, XP, Vista, 7 (64-bit support limited to Windows 7) For system environment settings such as CPU, memory and display, use an environment which conforms to that recommended by your OS.
- HDD space: 10 MB or more of free disk space

Specifications



Model 3145-20

<Input Section>

Input terminal : BNC jack
 Max. input voltage (between terminals) : 5 V peak
 Max. rated voltage to earth : +5 V
 Frequency range: 5 kHz to 100 MHz (-3 dB range)
 Measurement Range/Span

Measured parameter	Measurement Range	Measurement Span
Current (with 9754 sensor)	200 mA	2.0 mA _{P-P} to 280.0 mA _{P-P}
	2 A	0.020 A _{P-P} to 2.800 A _{P-P}
	20 A	0.20 A _{P-P} to 28.00 A _{P-P}
Voltage	10 mV	0.20 mV _{P-P} to 14.00 mV _{P-P}
	100 mV	2.0 mV _{P-P} to 140.0 mV _{P-P}
	1 V	0.020 V _{P-P} to 1.400 V _{P-P}

Measurement system : Seven contiguous bands defined by BPFs, measuring the peak value in each band

BPF configuration (BPF characteristics: Q = 1, -40 dB/decade roll-off)

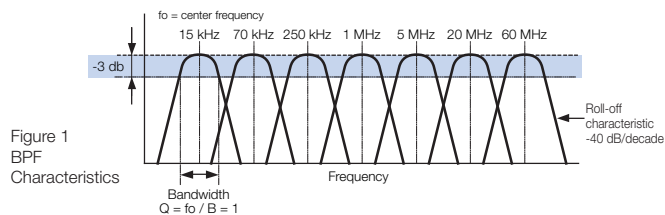

Figure 1
BPF
Characteristics

Peak value detection method: Waveform peak detection
 (for bands with fo = 15, 70 and 250 kHz, and 1 MHz)
 Level comparator
 (for bands with fo = 5, 20 and 60 MHz)

Measurement accuracy
 (at center frequency fo in each band, 0 to 40°C and up to 80% RH)
 - 1. 15, 70 and 250 kHz, and 1 MHz bands

Measurement Range	Signal Level	Band Center Frequency			
		15 kHz	70 kHz	250 kHz	1 MHz
200 mA	20.0 mA _{P-P} to 200.0 mA _{P-P}	±20% rdg.	±20% rdg.	±20% rdg.	±25% rdg.
2 A	200 mA _{P-P} to 2.000 A _{P-P}	±15% rdg.	±15% rdg.	±15% rdg.	±20% rdg.
20 A	2.00 A _{P-P} to 20.00 A _{P-P}	±15% rdg.	±15% rdg.	±15% rdg.	±20% rdg.

- 2. 5, 20 and 60 MHz bands

Measurement Range	Signal Level	Band Center Frequency		
		5 MHz	20 MHz	60 MHz
200 mA	200.0 mA _{P-P}	±25% rdg.	±25% rdg.	±30% rdg.
2 A	2.000 A _{P-P}	±20% rdg.	±20% rdg.	±25% rdg.
20 A	20.00 A _{P-P}	±20% rdg.	±20% rdg.	±25% rdg.

<General Specifications (Instrument)>

Internal memory: 32 MB
 Time axis accuracy: ±0.2 s/day (@23°C)
 Backup battery service life : For clock and settings: at least 10 years (@23°C)
 For measurement data: at least 10 min. after power off
 Operating temperature & humidity:
 0°C (32°F) to 40°C (104°F), up to 80% rh (non-condensating)
 Accuracy guaranty period: 1 year
 Product guaranty period: 1 year
 Dimensions: Approx. 203mm (7.99 in) W × 170mm (6.69 in) H × 52mm (2.05 in) D
 Mass: Approx. 1.2kg (42.3 oz)

Applicable standards Safety: EN61010-1:2001, Pollution degree 2, Measurement category I (anticipated transient overvoltage 330 V)
 EMC: EN61326:1997+A1:1998+A2:2001+A3:2003
 EN61000-3-2:2000+A2:2005
 EN61000-3-3:1995+A1:2001+A2:2005
 External memory PC Card slot: One 68-pin PC Card Standard-compliant Type II slot (supports Type I and II)
 Card type: Flash ATA Cards (Hioki brand)
 Stored content: Settings, measurement data (text or proprietary Model 3145 format), screen capture images (BMP format)
 Display Display device: 5.7-inch STN color LCD
 Display characters: English or Japanese, selectable
 Power Power supply: ① AC Adapter Model 9418-15 (provides 12 V DC ±5%)
 AC Adapter rated input voltage 100 to 240 V AC
 AC Adapter input frequency 50/60 Hz
 ② Battery Pack Model 9447
 Charging function: The AC adapter charges the Battery Pack 9447
 Quick-charge time: 2.5 hours or less (@23°C)
 Continuous operating time: Approx. 1 hour (@23°C, with High backlight setting)

<Functional Specifications>

Monitor function: Displays real-time peak-to-peak values in each frequency band on level meters
 Measured values: Peak-to-peak
 Display method: Level meter plus instantaneous or maximum values
 Refresh interval: 100 ms
 Peak-Hold function: Retains display of the maximum value measured in each band
 Logging function: Records maximum peak-to-peak values in each frequency band at the specified recording interval to internal memory, and displays a time-series graph
 Recording interval: 1, 2, 5, 10, 20, 30 or 60 s
 Recording duration: Determined by memory capacity
 Time-series graph display method: Full Screen, Time-Series Graph & Most-Recent Values or Time-Series Graph & Maximum Values
 Time-series graph zoom: Zooms in/out along the time axis
 Cursor function: Displays measured value at cursor position
 Alarm function: While logging or display monitoring, a specified operation is performed when specified criteria are met
 Alarm Criteria: Level settings can be specified for each band (logical OR criteria)
 Alarm operations: ① Audible beeps, ② Display indication, ③ Trigger output, ④ E-mail notification
 Event Mark function: Up to 100 Event Marks can be entered while logging
 I/O functions:

Applicable Voltage Range:	High level: 2.5 to 5.0 V Low level: 0 to 1.0 V
Effective Pulse width:	With external trigger filter Off, High interval: at least 1 ms, Low interval: at least 2 μs
	With external trigger filter On, High interval: at least 2.5 ms, Low interval: at least 2.5 ms
Maximum Applied Voltage:	-5 to +10 V DC

 (2) Trigger output: Signal output upon alarm event, open-collector, at least 100 ms pulse width
 Filter function Storage media: PC Card
 Saving format: Dedicated Model 3145-20 format, text, settings file, screen capture images (BMP format)
 Communication functions:
 HTTP server for screen display and remote control
 FTP server for data acquisition from internal memory and PC Card
 E-mail sending upon alarm events

<PC Application Program Specifications>

Reads the dedicated Model 3145-20 format, displays logged data, cursor function, search function, text file conversion, printing and screen capture

Model 9754

<Product Specifications>

Frequency range: 1 kHz to 100 MHz (-3 dB)
 Rated current: AC 10 A
 Maximum current: 15 A peak
 Output voltage ratio: 0.1 V/A
 Amplitude accuracy: ±3.0% rdg. ±0.001% f.s. (@10 A f.s.)
 (f = 15 kHz, with conductor centered in clamp)
 Accuracy guaranty period: 1 year (approx. 10,000 clamp open/close cycles)
 Conductor position effect: ±0.4% or less
 Residual current characteristic: 40 mA or less
 Maximum rated voltage to earth: CATII 600 V, CATIII 300 V (insulated conductor)
 Operating environment: Up to 2000 m ASL, indoors

Operating temperature & humidity: 0°C (32°F) to 40°C (104°F), up to 80% rh (non-condensating)
 Measurable conductor diameter: up to 20mm (0.79 in)
 Sensor cable length: Approx. 2m (6.56 ft)
 External dimensions: Sensor: Approx. 176mm (6.93 in) W × 69mm (2.72 in) H × 27mm (1.06 in) D
 Terminator: Approx. 27mm (1.06 in) W × 55mm (2.17 in) H × 19mm (0.75 in) D
 Mass: Approx. 450g (15.9 oz)
 Accessories: Instruction Manual
 Applicable standards Safety: EN61010-2-032:2002, B-type current sensor measurement categories II and III (anticipated transient overvoltage 4000 V), Pollution degree 2
 EMC: EN61326:1997+A1:1998+A2:2001+A3:2003



Model 3144-20

<General Specifications>

Input terminals: Dedicated terminal for Model 9741, BNC jack (9741 has priority)
 Input impedance: 9741 input: $50\ \Omega \pm 10\%$
 BNC input: $50\ \Omega \pm 10\%$
 $1\text{M}\Omega \pm 10\% / 120\ \text{pF} \pm 30\ \text{pF}$
 Maximum input voltage: 5 Vp-p
 Frequency range: 500 Hz to 30 MHz, in 7 contiguous ranges (-3 dB)

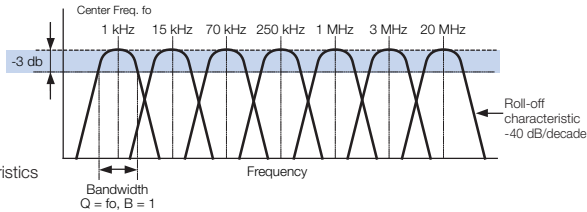

Figure 1
BPF
Characteristics

Measurement ranges: $\times 1$: 0 dBV (1 V) f.s
 $\times 10$: -20 dBV (0.1 V) f.s
 Detection method: RMS value conversion
 Detection accuracy: no more than $\pm 1.5\ \text{dBV}$ from 500 Hz to 1 MHz,
 $\pm 2.0\ \text{dBV}$ from 1 to 30 MHz

<Measurement Functions>

Monitor function: Displays voltage level measured in each frequency band on level meters
 Logging function: Records measured values and times at the specified recording interval to internal memory
 Internal memory: 8 blocks of up to 8,000 data points each
 Recording data capacity: Up to 64,000 data points in 8 blocks of up to 8,000 points each
 Recording modes: Measurement Stop Mode
 Measurement stops when internal memory becomes full (up to 64,000 data points) Overwrite Mode (CONT):
 When internal memory becomes full, the oldest data is overwritten as measurement continues, with a minimum of 56,000 data points stored
 Memory backup: Backup battery retains data in memory when power is off
 Backup battery service life is approximately 5 years (typical)
 Recording intervals: 1, 2, 5, 10, 20 or 30 s; or 1, 2, 5, 10, 20, 30 or 60 min
 Data deletion: All data is deleted at the same time
 Data display function: Shows measurement values and times recorded by the Logging function
 Peak Hold function: Shows peak values and detection times for each frequency band in Monitor, Logging and Data Display functions

<Output function>

Waveform monitoring: Outputs the signal from the 9741 dedicated input or the BNC input
 Frequency range: 500 Hz to 30 MHz (-3 dB, $50\ \Omega$ termination)
 Output impedance: $50\ \Omega \pm 10\%$ (@1 kHz)
 Input-output ratio: 2:1 ($50\ \Omega$ termination)
 Output accuracy: $\pm 5\%$ rdg. $\pm 10\ \text{mV}$ ($50\ \Omega$ termination)
 Max. open-circuit voltage: $\pm 4.5\ \text{V}$
 Audio monitoring: Output of envelope-detected signal

<Communication function>

Communication content: Transfers recorded data from the 3144-20's internal memory to a PC
 Interface: USB Ver. 1.1

<Other Specifications>

Power: Six AA-size (LR6) alkaline batteries, 9 V DC, 500 mA
 (AC Adapter Model 9445-02 or 9445-03, input voltage: 100 to 240 V AC, 50/60 Hz; max. rated current: 250 mA)
 Continuous operating time: Approx. 5 hours (on battery power)
 Operating temperature & humidity: 0°C (32°F) to 40°C (104°F), up to 80% rh (non-condensating)
 Low battery warning: The low-battery indicator appears when supply voltage drops to approx. 6.5 V
 Time setting: Year, month, day, hour, minute and second by key entry
 Applicable standards: Safety: EN61010-1:2001, Measurement category I, Pollution degree 2, anticipated transient overvoltage 330 V
 Dimensions: Approx. 98mm (3.86 in) W \times 179mm (7.05 in) H \times 46mm (1.81 in) D
 Mass: Approx. 430g (15.2 oz)
 Accuracy guaranty period: 1 year
 Product guaranty period: 3 years
 Functions of bundled application program: Data list display, time-series data waveform display, display of peak values and peak detection times, saving data, saving screen image to BMP, printing

Model 9741

<Product Specifications>

Sensor type: Electrostatically coupling non-contact voltage sensor
 Frequency range: 600 Hz to 30 MHz (-3 dB bands or more to 100 kHz)
 Sensor output: Voltage
 Output impedance: $50\ \Omega \pm 10\%$ (@1 kHz)
 Measurable conductor diameter: up to 20mm (0.79 in)
 Maximum rated voltage to earth: 200 V AC
 Cable length: Approx. 1m (3.28 ft)

Supply voltage: $\pm 5\ \text{V}$ (via connection to Model 3144-20)
 Operating temperature & humidity: 0°C (32°F) to 40°C (104°F), up to 80% rh (non-condensating)
 Applicable standards: Safety: EN61010-1:2001, Measurement category III, Pollution degree 2, anticipated transient overvoltage 4000 V
 EMC: EN61326:1997+A1:1998+A2:2001 Class B
 Dimensions: Approx. 62mm (2.44 in) W \times 158mm (6.22 in) H \times 40mm (1.57 in) D
 Mass: Approx. 260g (9.2 oz)
 Accuracy guaranty period: 1 year

The NOISE SEARCH TESTER 3144-20 is a commercial product based upon technologies of Nippon Telegraph and Telephone East Corporation Technology Center.

Appearance & Dimension Diagrams

Model 3145-20 Main Device Only

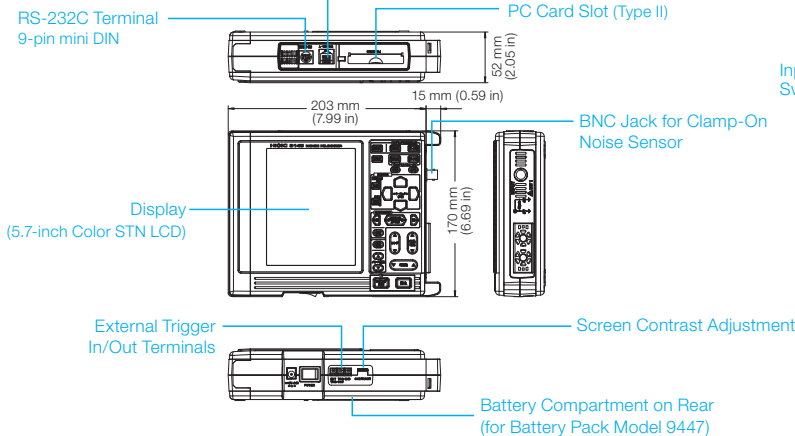

Model 3144-20 Main Device Only

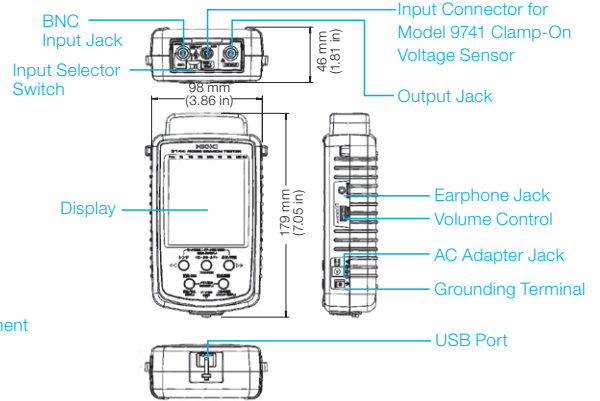

Options for Model 3145-20

Note: Names of products in this brochure are trademarks or registered trademarks of their respective companies.

Peripherals and PC-Related Options

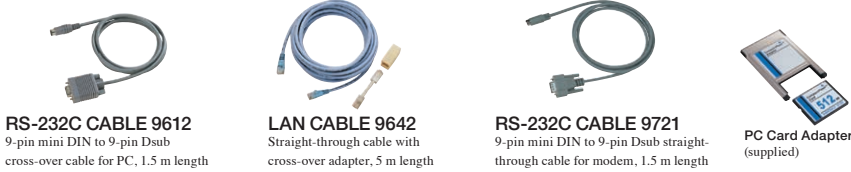

- PC CARD 128M 9726 (128 MB capacity)
- PC CARD 256M 9727 (256 MB capacity)
- PC CARD 512M 9728 (512 MB capacity)
- PC CARD 1G 9729 (1 GB capacity)

A PC Card is required to save measurement data. We recommend purchasing a PC Card at the time of ordering.

When purchasing a PC Card...

We recommend using only Hioki PC Card options. Other PC Cards may fail to read and write properly in the instrument, and proper operation cannot be guaranteed.

Clamp-On Noise Sensor



Power-Related Options



The BATTERY PACK 9447 can be charged in the NOISE HILOGGER with the supplied AC Adapter, without using the CHARGE STAND 9643. If the CHARGE STAND, AC Adapter and BATTERY PACK are purchased separately, the battery can be charged with a single device.

NOISE HILOGGER 3145-20

Supplied Accessories: AC ADAPTER 9418-15 x1, PC Application Disc (CD-R) x1, Carrying Strap x1, Carrying Case x1, Instruction Manual x1, Measurement Guide x1, Ferrite Chokes x3

Carrying Case Packing Example

[Stowed items]
3145-20 main unit
(AC Adapter 9418-15 with power cord)



The following are options:
CLAMP ON NOISE SENSOR 9754
BATTERY PACK 9447
CHARGE STAND 9643

Note: Measurement is not possible with the NOISE HILOGGER 3145-20 alone. The CLAMP ON NOISE SENSOR 9754 is required.

NOISE SEARCH TESTER 3144-20

Supplied Accessories: CLAMP ON VOLTAGE SENSOR 9741 x1, Carrying Case x1, PC Application Disc (CD-R) x1, AA-size (LR6) alkaline batteries x6, USB cable x1, AC ADAPTER 9445-02 (UL Type) x1 or 9445-03 (CEE Type) x1, Earphone x1, Strap x1, Instruction Manual x1



Note: Company names and Product names appearing in this catalog are trademarks or registered trademarks of various companies.

HIOKI
HIOKI E. E. CORPORATION

Headquarters :
81 Koizumi, Ueda, Nagano, 386-1192, Japan
TEL +81-268-28-0562 / FAX +81-268-28-0568
http://www.hioki.co.jp / E-mail: os-com@hioki.co.jp

HIOKI USA CORPORATION :
6 Corporate Drive, Cranbury, NJ 08512 USA
TEL +1-609-409-9109 / FAX +1-609-409-9108
http://www.hiokiusa.com / E-mail: hioki@hiokiusa.com

HIOKI (Shanghai) Sales & Trading Co., Ltd. :
1608-1610, Shanghai Times Square Office, 93 Huai Hai Zhong Road
Shanghai, P.R.China POSTCODE: 200021
TEL +86-21-63910090/63910092 FAX +86-21-63910360
http://www.hioki.cn / E-mail: info@hioki.com.cn
Beijing Office : TEL +86-10-84418761 / 84418762
Guangzhou Office : TEL +86-20-38392673 / 38392676
HIOKI INDIA PRIVATE LIMITED :
Khandela House, 24 Gulmohar Colony Indore 452 018 (M.P.), India
TEL +91-731-4223901, 4223902 FAX +91-731-4223903
http://www.hioki.in / E-mail: info@hioki.in
HIOKI SINGAPORE PTE. LTD. :
33 Ubi Avenue 3, #03-02 Vertex, Singapore 408868
TEL +65-6634-7677 FAX +65-6634-7477
E-mail: info@hioki.com.sg

DISTRIBUTED BY